



# COMMUNITY COMPOSTING DONE RIGHT

**A Guide to Best Management Practices**

*by Linda Bilsens Brolis and Brenda Platt*

**Neighborhood  
Soil Rebuilders**

**COMPOSTER TRAINING PROGRAM**

## About the Institute for Local Self-Reliance | [ilsr.org](https://ilsr.org)

The Institute for Local Self-Reliance (ILSR) is a national nonprofit research and educational organization that since 1974, has championed local self-reliance, a strategy that underscores the need for humanly scaled institutions and economies and the widest possible distribution of ownership. ILSR's mission is to provide innovative strategies, working models, and timely information to support strong, community rooted, environmentally sound, and equitable local economies. Our Composting for Community Initiative is advancing composting to enhance local soils and community health, support local food production, sequester carbon, cut waste, and create community development opportunities. We are specifically interested in catalyzing distributed food residual composting options – home, community, and on-farm composting – in addition to larger-scale facilities. This report is part of our ongoing work to promote and support the burgeoning community-based composting movement. For more information, visit <https://ilsr.org/composting/>.

## About the Authors

**Linda Bilsens Brolis** is the Project Manager for ILSR's Neighborhood Soil Rebuilders (NSR) Composter Training Program. Her work with ILSR began in December 2013 with an initial focus on state food residual recovery policies. She then led a nationwide survey of Master Composter training programs, and has managed the NSR program since it launched in 2014. The NSR train-the-trainer program is designed to be adapted and replicated as a model for community composting training around the country. Linda was the lead author of ILSR's 2018 *Guide to Composting Onsite at Schools*. She is a certified Compost Facility Operator in the state of Maryland, and has trained with the internationally renowned Lubkes in Austria, who specialize in a unique technique that enhances the humus content and quality of compost.

**Brenda Platt** is the director of ILSR's Composting for Community Initiative. She has worked more than three decades fighting trash burners and promoting waste reduction, recycling, and composting. She has authored numerous reports on composting including: *The State of Composting in the U.S.: What, Why, Where, and How*, *Growing Local Fertility: A Guide to Community Composting*, *BioCycle's Residential Food Waste Collection Access Study*, *Yes! In My Backyard: A Home Composting Guide for Local Government*, and *Micro Composting: A Guide to Small-scale and On-site Food Scrap Composting Systems*. In 2017, the U.S. Composting Council awarded Platt its H. Clark Gregory Award for outstanding service to the composting industry through grassroots efforts. She has been certified twice in Maryland to operate commercial scale facilities.

*The authors thank EPA Region 4, Virginia Cretella Mars Foundation, the 11th Hour Project, the Lisa and Douglas Goldman Fund, and our other donors for their support. Thanks to Clarissa Libertelli for creating custom illustrations and to our colleague at ILSR, Jessica Del Fiacco for the report layout. Inspiration for this guide was drawn from the Neighborhood Soil Rebuilders Composter Training Program, the US Composting Council, the NRAES On-Farm Composting Handbook, the NYC Compost Project, and the DC DPR Compost Cooperative Network. Thanks to Benny Erez (ECO City Farms), Jeffrey Neal (Loop Closing), Nadine Bloch (Beautiful Trouble), Lynn Fang (compost biologist), Ula Chrobak (former ILSR intern), and Bobby Bell (former ILSR staff) for their contributions to earlier versions of this document. Sincere thanks also to Virginia Streefer of ILSR, Craig Coker of Coker Composting and Consulting, Marisa DeDominicis of Earth Matter NY, Marion Ecks of Kompost Kids, Domingo Medina of Peels and Wheels, James McSweeney of Compost Technical Services, Susan Wood of the Georgia Environmental Protection Division, Jeremy Hooper of the Tennessee Department of Environment and Conservation, and Erik Martig of Conscious Compost for their thoughtful review.*

Cover photo credit, clockwise from top left:

A secure and clearly labeled food scrap drop-off container at Sunshine Community Compost in Sarasota, Fla. *Source: Institute for Local Self-Reliance.*

Participants of the composting project at East Capitol Urban Farm in Washington, D.C., established by ILSR, build a new composting pile using a mixing bin, a tarp, and a gravel pad. *Source: Institute for Local Self-Reliance.*

Youth staff and board members of BK ROT in Brooklyn flipping composting piles and cleaning up during a work day. *Source: Valery Rizzo.*

Located on Governors Island, the NYC Compost Project hosted at Earth Matter NY demonstrates how to produce and use compost in its Compost Learning Center. *Source: Earth Matter NY.*

# Table of Contents

## Introduction ..... 4

## PART 1 For New Composters and New Sites .....9

**Composting Basics ..... 10**  
Learn about the ingredients for good compost. This is a good introduction for new composters.

**Before You Begin ..... 12**  
Before composting can begin, you will need a site and a general plan.

**3 Steps to Get Started ..... 18**  
A checklist for preparing to compost once you have a site and a plan.

## PART 2 The Science and Art of Composting ..... 30

**Determine Your Composting Recipe ..... 30**  
An overview of the science behind developing a composting recipe.

**Building Your Composting Pile ..... 34**  
How to build a well-structured pile using composting science principles.

## PART 3 Managing the Composting Process and Your Site ..... 41

**Turning or Remixing ..... 41**  
Regularly turning your composting pile will help create a higher quality end-product.

**Monitoring and Keeping Records ..... 43**  
Measuring and tracking certain parameters will help you manage the composting process.

**Finishing the Composting Process ..... 47**  
Learn about the importance of curing and how to identify when your compost is done.

**Using Finished Compost in the Garden ..... 51**  
There are many uses for your hard-earned black gold.

**Health and Safety Considerations ..... 53**  
An overview of practices for good hygiene and safety.

**Community Composting Best Management Practices ..... 55**  
A review of the practices that will put you on the path to success and creating high-quality compost.

## Appendices

**A. Glossary of Terms ..... 59**  
Definitions for terms that may be new to some composters and are bolded and italicized throughout the guide.

**B. Troubleshooting FAQ ..... 62**  
Answers to common questions related to managing a composting site.

**C. Troubleshooting Table ..... 64**  
Odors? Nothing happening? Learn tips for dealing with challenges.

**D. Sample Composting Pile Monitoring Data Sheet ..... 67**  
Recordkeeping is key to success. Here is a sample data collection sheet to use at your site.

**E. Community Composting in Georgia ..... 69**  
Rules to be aware of for those composting at the community-scale in the state of Georgia.



## Introduction

Compost is a valuable soil-amendment product that can increase local environmental and social resilience. When compost is incorporated into local soils, it improves their ability to withstand floods and droughts, sequester carbon, filter pollutants, retain nutrients, and support local food production. If done in a way that directly engages and serves a local community, composting can help build local social capital and wealth. This is community composting.

In this age of climate chaos, social inequality, and political divisiveness, composting provides a practicable local solution to benefit the environment and our communities. When composting is done locally, it reduces the amount of heavy, wet, and putrescible organic materials that need to be transported and thrown “away.” There is no “away” and often communities with the least political capital – primarily low-income communities and communities of color – end up bearing the burden of pollution and associated health impacts from landfills and incinerators.<sup>1</sup> Composting, on the other hand, transforms discarded yard trimmings,

▲ ECO City Farms in Prince George's County, Maryland, near Washington, D.C. composts a mix of farm residuals, leaves, wood chips, and food scraps to feed their soils. Source: *Institute for Local Self-Reliance*.

1 Paul Mohai and Robin Saha. “Which came first, people or pollution? Assessing the disparate siting and post-siting demographic change hypotheses of environmental injustice.” *Environmental Research Letters* (2015): 16-17.

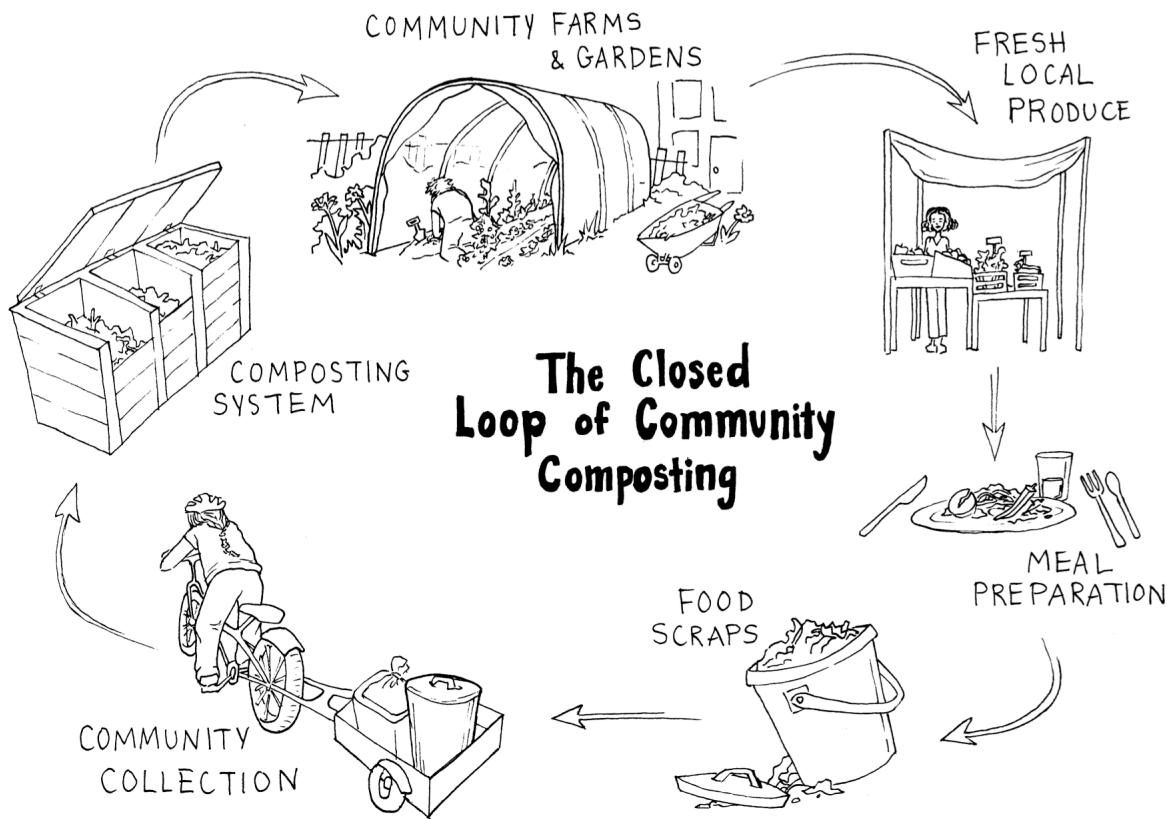

▲ Community composting helps close the local food loop. Food scraps can be transformed into compost, which can be added back to soil to help grow more fresh food. Source: Institute for Local Self-Reliance.

food scraps, and other organic materials from liabilities to assets. As we documented in our 2014 report, *Growing Local Fertility: A Guide to Community Composting*,<sup>2</sup> community composting keeps the process and product as local as possible while engaging the community through participation and education.

At this relatively small scale, compost is produced and used within the same community in which the material is generated. Community composters represent a wide range of initiatives in different venues, using different systems, from in-vessel systems at schools to custom-built 3-bin options at urban farms. As composting systems can be tailored to meet different levels of available time and effort, community composting programs range in size. But, they have a common goal to serve a given community within a closed resource-use loop. The distinguishing feature of community composting is retaining organic materials as a community asset and scaling systems to meet the needs of a self-defined community while engaging, empowering, and educating the community.

Community composters help to make composting more accessible to the public. With this comes greater visibility and sometimes scrutiny. Composting is an age-old practice, but it is also a science and an art. To produce high-quality, mature compost without creating nuisance odors and attracting pests takes forethought, attentiveness, and practice. Compost site operators need to know how to optimize certain conditions to avoid problems, regardless of the size of the site or the volume of material processed. Training with and learning from more experienced composters is one key to success. For these reasons, the Institute for Local Self-Reliance's Composting for Community Initiative launched the Neighborhood Soil Rebuilders (NSR) Composter Training Program in Washington, D.C., in 2014 in partnership with ECO City Farms, a local urban teaching farm. The NSR Program has developed this set of best management and monitoring practices for small-scale community-oriented composting.

Though small-scale composters are often exempt from certain state permitting or local zoning requirements, it is

<sup>2</sup> Brenda Platt, Institute for Local Self-Reliance, and James McSweeney and Jenn Davis, Highfields Center for Composting (now defunct), *Growing Local Fertility: A Guide to Community Composting* (2014), available online at: <https://ilsr.org/size-matters-report-shows-small-scale-community-based-composting>.

# Hierarchy to Reduce Food Waste and Grow Community

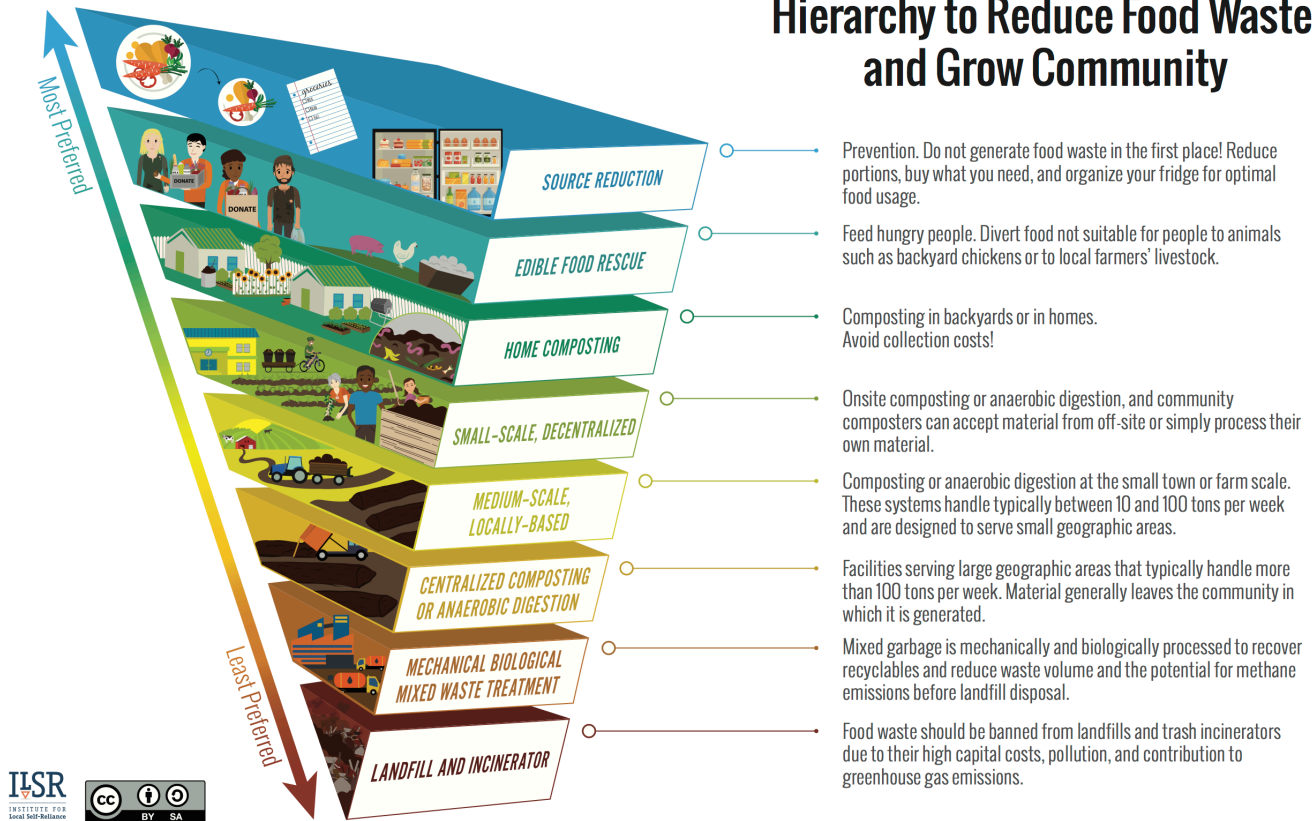

▲ ILSR's Hierarchy to Reduce Food Waste and Grow Community highlights the importance of locally based composting solutions as a priority over large-scale regional solutions. Available for download in poster and other formats at <https://ilsr.org/food-waste-hierarchy>. Source: Institute for Local Self-Reliance

paramount that they follow best management practices. To ensure composting remains a viable option, particularly in urban settings, strive for high quality without nuisances. Well-run composting demonstration sites are critical to improving people's understanding of what good compost is and how it is made. Such sites can help garner support from neighbors, the general public, and policymakers for composting at all scales. But, regardless of whether or not your site is open to visitors, good site hygiene and attentive management will be critical to your success.

*Community composting keeps the process and product as local as possible while engaging the community through participation and education.*

**Community Composting Done Right: A Guide to Best Management Practices** is designed to support community-scale composters in successfully managing their composting

## SPOTLIGHT - Types of Community Composting Initiatives

In our 2014 report, *Growing Local Fertility*, we categorized community composting initiatives into 10 main types, based either on the type of venue (such as school or farm) or the type of operation (such as collector or composter). Community composters can fall into more than one category.

1. Community gardens
2. Farms
3. Schools
4. Drop-off networks
5. Collection entrepreneurs
6. On-site composters
7. Off-site composters
8. Demonstration and community leader training sites
9. Worker-owned cooperatives
10. Home-based or homesteader hubs

Source: Growing Local Fertility: A Guide to Community Composting <https://ilsr.org/size-matters-report-shows-small-scale-community-based-composting/>



## SPOTLIGHT - Benefits of Community Composting

**Increased Local Economic Vitality** Locally-based composting circulates dollars in the community, promotes social inclusion and empowerment, greens neighborhoods, supports local food production and food security, embeds a culture of composting know-how in the community, sustains local jobs, and strengthens the skills of the local workforce.

**Community Engagement** Composting is a direct way to be active in caring for the earth and our community. Participants learn firsthand how garden trimmings and food scraps can be recycled into compost to grow more food. Neighbors come together for a common cause, improving the social fabric of the community.

**Improved Soil** Compost enhances soil structure to better withstand droughts and floods. It helps soil hold more water, reducing the need for watering. Compost also improves soil fertility and health, and the ability of plants to fight pests and diseases. Without healthy soils, we cannot have healthy foods.

**Pollution Mitigation** Amending contaminated soils with compost reduces the bioavailability of lead and arsenic. Compost also filters pollutants from urban stormwater.

**Waste Reduction** Composting diverts organic materials from landfills and trash burners, which are highly polluting.

**Climate Protection** As organic material decomposes in landfills, it emits methane, a very potent greenhouse gas. But when added to soil, compost sequesters carbon. It's a win-win!

**Applied Learning** In projects that are located at schools or otherwise engage youth, soil-food-web curriculum goals can be reinforced in an active learning environment.

process and site, with a particular focus on sites accepting food scraps. It is divided into three parts.

**Part 1: For New Composters and New Sites** summarizes composting basics, site and site plan considerations, and steps to prepare for composting.

**Part 2: The Science and Art of Composting** provides a deep dive into the composting pile with an overview of important composting science principles.

**Part 3: Managing the Composting Process and Your Site** reviews monitoring and recordkeeping, curing and using finished compost, best management practices, and health and safety considerations.

**Community Composting Done Right: A Guide to Best Management Practices** adapts standards of practice from the commercial composting industry for the community scale. Much of the information will apply regardless of the system being used, but it is not intended as a guide to home composting. For information on government-supported home composting programs, see our May 2018 report, [Yes! In My Backyard: A Home Composting Guide for Local Government](#). For information on small-scale composting systems, see our May 2019 companion report to this guide, [Micro Composting: A Guide to Small-scale and On-site Food Scrap Composting Systems](#). For more information on community composters, see our 2014 report, [Growing Local Fertility: A Guide to Community Composting](#).

We hope that **Community Composting Done Right: A Guide to Best Management Practices** will serve as a resource to new and existing community composters alike.

Happy composting!

### Feedback and Updates Welcome

Share your feedback, updates, and information about new or innovative programs.

#### CONTACT US

[composting4community@ilsr.org](mailto:composting4community@ilsr.org)  
[ilsr.org/composting](http://ilsr.org/composting)

# Composting Enhances Soil and Protects Watersheds

Healthy soils are essential for protecting watersheds. Compost is the best way to add organic matter—which is vital—to soils.

When added to soil, compost can filter out urban stormwater pollutants by an astounding **60-95%**



## IT'S ALL ABOUT THE SOIL

**COMPOST** improves biological, chemical, and physical characteristics of soil.

Protects against soil desertification and soil erosion

Enhances plant disease suppression

Increases resilience to floods and droughts

Increases soil fertility

Reduces need for chemicals

Converts nitrogen into a more stable and less mobile form and phosphorous into a less soluble form

Increases microbial activity

Improves water retention

Improves soil structure

Improves ability to store nutrients (such as cation exchange capacity)

Adds humus, keeping soil particles stuck together

Compost serves as a filter and sponge. It immobilizes and degrades pollutants, improving water quality.

Compost helps reduce stormwater runoff because it can hold **~5x its weight** in water.

◀ This poster is part of a series. ILSR's Compost Impacts Posters highlight the benefits of the composting process and improving soil with compost. Available for download in poster and other formats at <https://ilsr.org/compost-impacts-posters/>. Source: Institute for Local Self-Reliance

**ILSR** INSTITUTE FOR  
Local Self-Reliance

To learn more, visit: [www.ilsr.org](http://www.ilsr.org)





▲ BK Rot in Brooklyn, started by Sandy Nurse and Renee Peperone in 2013, pays a living wage to local youth who manage the bike-powered food scrap collection and composting enterprise. Source: Valery Rizzo.

## PART 1

# For New Composters and New Sites

**Compost** is a dark, crumbly, earthy-smelling and *humus*-rich material produced by the natural **aerobic** decomposition of organic materials such as garden trimmings and food scraps. When added to soil, compost improves its biological, chemical, and physical characteristics, making the soil a better home for plants and beneficial soil organisms.<sup>3</sup>

**Composting** is the transformation of raw organic materials into compost. It is a natural process that is driven by **microorganisms (or microbes)**, like bacteria and fungi, which break down **organic materials** as a food source. Composting is the way that nature recycles! We can speed the process by creating the ideal conditions for the microbes to thrive: adequate airflow, sufficient moisture, and the right recipe or food.

Words in **bold and italics** are defined in the glossary, on page 59.

<sup>3</sup> Though it is a common mistake to refer to them as “compost,” food scraps and other organics are not considered compost until they have been put through the composting process.

## PART 1 For New Composters and New Sites

### Composting Basics

Part 1 of this guide introduces basic composting concepts for new composters, then outlines considerations for site selection and planning. The section ends with an overview of a few key steps for preparing to compost.

#### Types of Composting

**Passive or cold composting** is a low-effort method of composting that involves little attention to turning and watering or otherwise optimizing composting conditions. Because of the lack of management, materials won't break down as quickly and it may take more than a year to produce finished compost. Weed seeds and pathogens may persist, as temperatures at or above 131°F are needed to kill them. This method is not appropriate for community sites composting food scraps.

**Active or hot composting**, also referred to as **thermophilic composting**, is a method of composting that involves more attention to piles so that they achieve higher temperatures, which also results in a faster composting process. Temperatures higher than 104°F are considered thermophilic conditions, but 131°F or higher will be needed to kill weed seeds

and pathogens. This approach produces a finished product more quickly than passive composting does. In order to reach optimal temperatures, regularly turn the pile and maintain adequate moisture. The time it takes to produce finished compost can vary greatly and is dependent on the recipe used and level of management applied.

#### Compost Decomposers

Composting is easier and a whole lot more fun with friends! Lucky for us, we have a countless number of willing allies ready to dig in.

**Microorganisms**, or microbes, are the workforce of your composting pile, chemically transforming raw materials into stabilized humus. They are too small to see with the naked eye. In a pile, bacteria eat up the fruit and vegetable scraps, which are full of simple and energy-rich components such as sugars and starches. As they reproduce, their activity generates heat in the pile and allows other microorganisms to begin their work. **Actinobacteria** and **fungi** both work to break down leaves, stems, nut shells, bark, and wood, which are full of more complex components such as **cellulose** and **lignin**.

**Macroorganisms** are larger organisms that mostly act as "shredders," chewing materials into smaller pieces that are more accessible to microbes. Macroorganisms include animals and insects such as snails, earthworms, nematodes, millipedes, flies, and beetles. Macroorganisms thrive in **mesophilic** conditions (temperatures less than 104°F). They are important to the decomposition process, but they also benefit from it. They feed on the microbes that break down organic materials into their components and are an indicator of the presence of microbes. In hot composting, the return of macroorganisms after a period of high temperatures also signals that the pile is past the thermophilic phase.

#### The Basic Ingredients of Composting

Compost requires organic materials substrates, also known as **feedstocks**, which are the materials our composting microbes will consume. In composting, **organic materials** refers to anything that was once alive. All organic materials contain carbon and nitrogen along with other elements in varying proportions. Carbon and nitrogen are particularly important for composting microorganisms to thrive and do their work. Microbes need a balanced diet of carbon for



▲ Rust Belt Riders's Nathan Rutz turns a thermophilic composting pile to produce compost for the local food system in Northeast Ohio. Source: Jacob Koestler.

# THE COMPOST PILE FOOD WEB

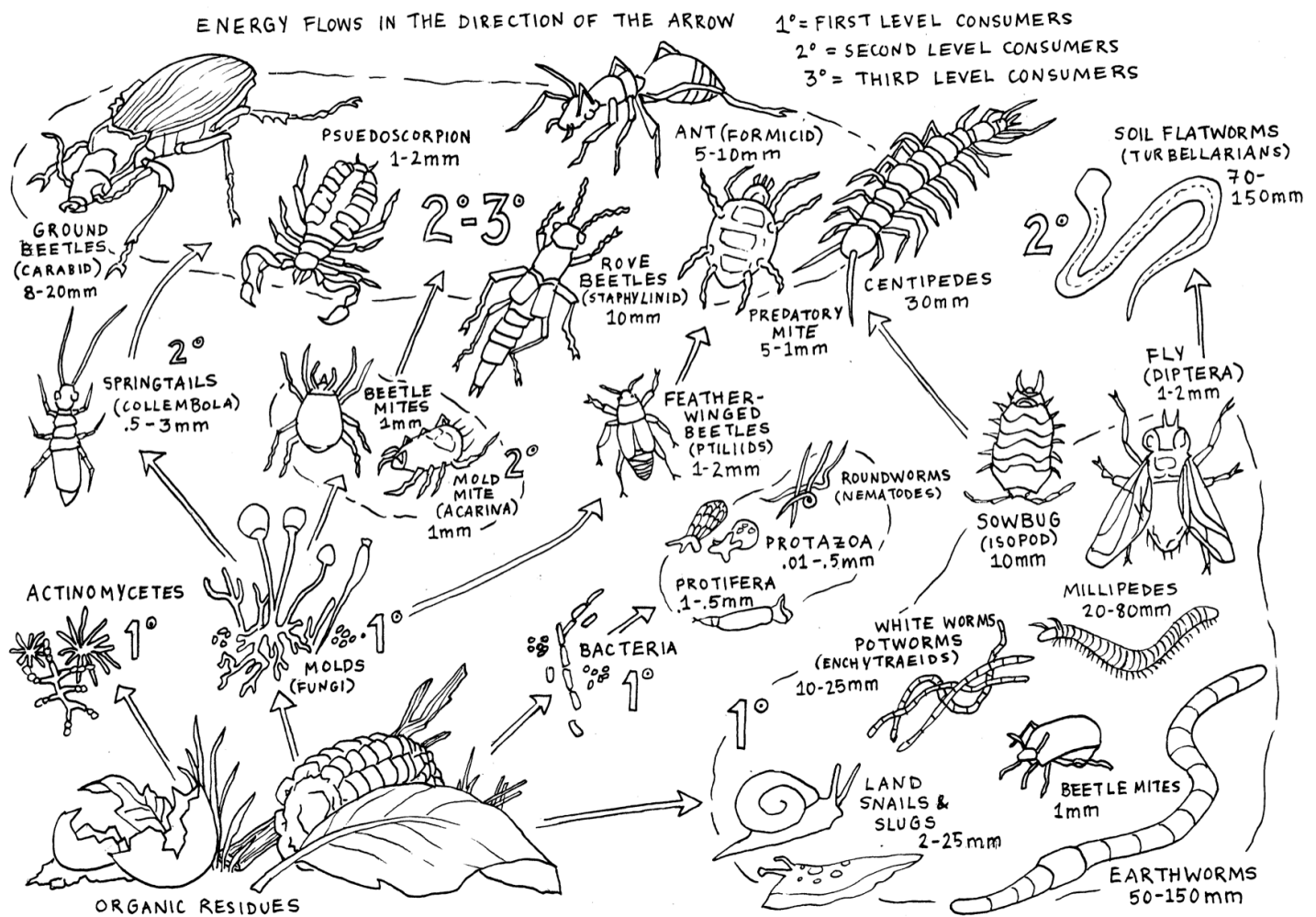

▲ A healthy compost pile is home to a diverse and complex ecosystem of organisms that each play a role in the decomposition process. Illustration recreates D. L. Dindal's original image ("Soil Organisms and Stabilizing Wastes," *Compost Science/Land Utilization* (1978): 8-11).

energy and nitrogen to grow and reproduce. Like us, these microorganisms also need water and air to live.

Composting is a bit like baking bread. In baking, you need to combine particular ingredients in specific proportions to feed the yeast that makes the bread rise appropriately and contributes to its good flavor. In composting, we combine certain "ingredients" to feed the activity of our composting microbes. Here we introduce four key ingredients to keep our composting microbes happy. We will discuss the specific proportions needed of each of these composting ingredients in Part 2.

**GREENS:** "**Greens**" are fresh materials relatively high in nitrogen such as raw vegetable and fruit scraps, coffee grounds, fresh grass clippings, and garden trimmings.<sup>4</sup> High-nitrogen materials help the microbes produce proteins. Greens can also help provide needed moisture in the pile.

Too many **putrescible** greens (materials that degrade easily) can lead to odor problems. When in doubt, add more browns!

**BROWNS:** "**Browns**" are materials relatively high in carbon such as fall leaves, wood chips and shavings, straw, shredded newspaper, and woody yard and garden trimmings. Browns are key to the microbes' balanced diet as they provide the energy needed to metabolize proteins and other nitrogenous compounds. Bulky brown materials such as wood chips can provide needed porosity and create pathways for fresh oxygen to enter the composting pile throughout the composting process.

**WATER:** Adequate moisture is essential for the microbes to thrive. The bacteria and fungi that drive the process live and swim in a water layer around organic particles and rely on that water to transport dissolved nutrients needed for their

<sup>4</sup> Though this categorization is a useful rule of thumb, not all "greens" are literally green, and not all "browns" are literally brown. Coffee grounds, for example, are high in nitrogen and considered a "green" material for the purpose of composting.

## GREENS

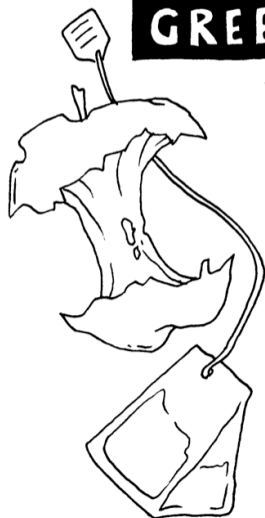

Fresh materials that are relatively high in nitrogen, such as raw vegetable & food scraps, green leaves, and coffee grounds.

## WATER



Decomposer microbes require a layer of water on organic particles to move around and metabolize dissolved nutrients.

## INGREDIENTS FOR GOOD COMPOST

## BROWNS

Materials that are relatively high in carbon, such as leaves, twigs, wood chips & shavings, straw, and shredded newspaper.



## AIR

Just like us, decomposer microbes "breathe."

Composting is an aerobic, or oxygen-requiring process.



▲ Four key ingredients are needed to create a composting pile that provides a hospitable environment for our composting microbes. Source: *Institute for Local Self-Reliance*

metabolic activities. Too little water, the microbes will go dormant. Too much water, the microbes will drown. The ideal moisture content for an actively composting pile is 45 to 60 percent,<sup>5</sup> which feels like a wrung-out sponge.

**OXYGEN:** Composting is an **aerobic** process, which means it requires oxygen. If oxygen levels in the pile drop too low, composting microbes will die or go dormant, and the pile may go **anaerobic** and start to smell. The ideal oxygen level is 10 percent or higher.<sup>6</sup> As microbial populations grow and increase activity, they consume oxygen in the pile. A proper compost recipe allows for airflow in the pile and is achieved by creating a porous mix.

### Before You Begin

Composting is a natural, practical, and beautifully transformational process. It's an ecological activity that

happens with or without the intervention of humans. With a little guidance and practice, practically anyone can learn to compost. This makes it possible to create a distributed and diverse composting infrastructure tailored for any community. We encourage anyone interested in composting to find a way to support or start a composting project in their community. However, it is critical to be intentional from the very beginning. Whenever we intervene in the composting process, we must take responsibility for it. By concentrating **putrescible** materials – or organic materials that decompose readily – in one place, it is on us to assure that we are not impacting our neighbors, wildlife, or the environment negatively. This section outlines what to consider before you start composting.

### Clarify Goals, Team, and Method

Composting is immensely flexible. Do you prefer a more passive system that doesn't require as much attention to

5 U.S. Composting Council, *Compost Operations Training Course*. (2015).

6 U.S. Composting Council, *Compost Operations Training Course*. (2015).

## PART 1 For New Composters and New Sites

turning and watering?<sup>7</sup> Or do you prefer the other end of the spectrum, where the composting process is optimized, hot temperatures are reached to kill weed seeds and potential pathogens, and participants are engaged and trained in its management? You can decide how much attention and effort to devote to it. The level of management you, your team, and your composting system can sustainably commit to will determine the quantity and types of materials your project can process. Regular and active management will generally allow your site to maximize the volume of inputs that can be handled, while speeding up the composting process and creating a higher quality final product.

### CLARIFY YOUR GOALS

If you are looking only to compost garden or yard trimmings, and/or small amounts of fruit and vegetable scraps from your kitchen, and you are creating compost for personal use, the management needed to keep your compost from creating nuisance issues will be minimal. In this case, passively managed systems may be an appropriate option. For community-based projects wanting to either compost food scraps collected from more than one household or produce compost for local food production, active management will be needed. Active management includes meeting the **Process to Further Reduce Pathogens (PFRP)** guidelines for thermophilic composting (described in the Management section on page 45), and following the best management practices for avoiding pest and nuisance odor issues outlined in this guide.



▲ The DC Department of Parks and Recreation's Community Compost Cooperative Network requires at least one active manager at each of its 50+ sites. The cooperative at Howard University pictured here. Source: Loop Closing.

*For community-based projects wanting to either compost food scraps collected from more than one household or produce compost for local food production, active management will be needed.*

### IDENTIFY YOUR TEAM

Who can help you? Composting sites that process food scraps need at least one designated composting site manager in place. Identify the composting system manager(s) who will be responsible for training other operators and site participants and volunteers. That person can take a leadership role in establishing a composting team or otherwise engaging participants. Identifying and training additional managers and recruiting qualified helpers of all ages to assist the operating team can be beneficial and make work days more fun. Requiring regular compost shifts for participants ensures a smoother and more collaborative effort. One possible arrangement would be weekly shifts for managers and monthly shifts for other participants. There's an art to having volunteers contribute to the project in a meaningful way without overwhelming them. Providing volunteers with ample training, specific directions, and easy access to needed tools are key. Expanding the group of knowledgeable composters involved in the project will also enhance the project's success and impact.

*Composting sites that process food scraps need at least one designated composting site manager in place.*

### TRAINING MATTERS

In need of a composting team? Are there experienced composters in your community to learn from or to engage in your project? Composting is a natural part of farming and gardening, making local farms and gardens ideal partners and hosts for composting projects. Many communities have Master Gardener programs, often associated with land-grant universities and the Cooperative Extension System, which may teach a module on composting. Some communities even have Master

<sup>7</sup> Note: we discourage the use of static piles that does not involve some turning, particularly for food scrap composting. Turning and watering optimizes the process. No reputable composter would leave a pile unturned or without aeration.

## PART 1 For New Composters and New Sites



▲ The Institute for Local Self-Reliance and ECO City Farms launched the Neighborhood Soil Rebuilders Composter Training Program in 2014. NSR lead instructor, Benny Erez, third from right. Source: Institute for Local Self-Reliance.

Composter programs. If you are looking to get trained, finding a composting mentor or an existing Master Composter program to participate in are good options. If your community doesn't yet have a Master Composter program, the Institute for Local Self-Reliance and ECO City Farms' Neighborhood Soil Rebuilders composter training program was designed to be replicated. The U.S. Composting Council also hosts regular Compost Operations Training Courses in different locations throughout the country.

### DEVELOP A MANAGEMENT PLAN

What will be your management plan and who will be responsible for what? If you do not have a budget for equipment to help with mixing and turning, building new piles and turning existing piles is likely to be the most labor-intensive part of your project. Be realistic about what your team can manage – start small and simple! A group of managers will lighten the load on any one person.

An example management arrangement for a community composting site might look like this:

#### 2-3 composting site managers

- monitor compost temperatures,
- lead community work days,
- determine what the composting pile needs, and
- manage incoming feedstocks and outgoing compost.

#### 1-2 communications and data managers

- communicate with the community members and partners,
- communicate needs from the composting site managers to any decision makers,
- organize volunteer work days, and
- keep track of data, such as compost recipes used, people engaged, and pounds of material composted.

Compensating managers to do this work is ideal in order to ensure people stay engaged and that the composting process remains a top priority. Trained composters who are dedicated and responsible are an asset. Managing a composting project takes work and unpaid volunteers may not be as accountable as someone who is paid. High turnover and having to spend significant time retraining new managers can be the downfall of a project. Paying composters a living wage helps legitimize and build pride in this work while investing in a community-based economy. Employing local residents, particularly those most often marginalized, builds local wealth and helps shift entrenched power dynamics.

---

*Paying composters a living wage helps legitimize and build pride in this work while investing in a community-based economy. Employing local residents, particularly those most often marginalized, builds local wealth and helps shift entrenched power dynamics.*

If at a farm or garden, perhaps this money could come out of funds otherwise spent on buying compost, or from charging for garden plots or membership fees, or perhaps helping with the compost is a work-exchange option. If you are collecting materials from the community, perhaps you can charge a collection service fee, partner with a host organization, host a crowdfunding campaign, or write a grant proposal to help cover your startup and operation costs. Perhaps you want to start a community composting business. The community composting movement encompasses enterprises with diverse management

## PART 1 For New Composters and New Sites

and ownership structures. Learn more at <https://ilsr.org/composting/community-composters/>.

### Site Selection and Design

The physical characteristics of your compost site and local laws and regulations will influence how you lay out the components of your site, what system you employ, and what site-specific management practices will be needed. Community composters don't always have a choice as to where to set up their composting system, so they have to do the best with what they have. This section is intended to outline characteristics of an ideal community composting site, but modifications can and should be made to accommodate local rules and make less-than-ideal sites work.

### LAWS AND REGULATIONS

There are laws and regulations at the state, county, and city levels that may impact where, what, and how much you can compost. Local zoning rules may determine where you can and cannot compost. Permitting rules for composting facilities will likely play a role in determining what you can and cannot compost, how large your composting area will be, and how much material you can have onsite at any given time. There may be other mandated management and design requirements, such as how you manage stormwater, what information needs to be on signage at your site, testing of feedstocks and finished compost, and whether you need to register and label finished compost for sale. What are the rules in your community?

Become familiar with state and local codes, paying particular attention to the definitions section and checking for a list of exemptions for each regulation.<sup>8</sup> The Sustainable Economies Law Center (SEL) categorizes the laws that may apply to community composters in the following way:

- Laws that protect against air or water pollution, odors, pests, unattractive compost bins or facilities, traffic, and inaccurate fertilizer labeling
- Laws and programs to divert waste from landfills, streamline composting, and improve soil

The good news is that small-scale community composting is often exempt from many state permitting rules. These exemptions are typically based on feedstocks accepted,

the square footage of your site, or the volume of material stored or processed. Some states may not even cover community or small-scale composting. Do not view this lack of clarity and guidance as a regulatory “free pass,” but instead be even more encouraged to follow widely accepted best management practices. Also seek a seat at the table whenever composting regulations are being discussed. As community and small-scale composting gain in popularity, public scrutiny and rules that affect your operation are likely to follow.

### SITE LAYOUT

The location and topographical characteristics of your composting site will determine factors such as how the wind blows (bringing potential odors with it), how water moves across the site during heavy rain events, how and



In 2017, the Institute for Local Self-Reliance partnered with the University of the District of Columbia's College of Agriculture and Urban Sustainability to launch the East Capitol Urban Farm Compost Project. The site is laid out in a linear pattern: feedstocks enter on one side, and finished compost exits the other. Clear signage informs the surrounding community of how to participate. Source: *Institute for Local Self-Reliance*.

8 Sustainable Economies Law Center, “Compost Legal Research Roadmap” (2017). Available at <https://sites.google.com/thesecl.org/communitycompostlaw>.

## PART 1 For New Composters and New Sites

where water drains from your site, existing pest pressures, and your proximity to neighbors.

The overall layout of your site will determine how people and materials will move through it. Think about what layout will maximize efficiency and minimize effort and mess from moving materials around.

Consider where feedstocks (material inputs) will enter the site, where they will be stored, where compost will be cured, and where finished compost will be stored or used to make space for more incoming material.

Here is a list of common components of community composting sites:

- An enclosure or designated space to store browns
- Feedstock receiving and mixing areas
- Tools or equipment for moving, measuring, and mixing feedstocks
- Critter-resistant composting system
- Enclosures or designated space for curing and finished compost
- Sifter for screening finished compost
- Scales for weighing feedstocks and finished compost
- Informational signage with clear instructions and contact info
- Source of electricity (if needed) and access to water

Compost production is optimized when materials are moved in the straightest line possible from start to finish, with the fewest material handling steps. Ideally, your active composting system will be found in the middle, with space for mixing and moving around. Access to water and electricity are important considerations, and equipment and tools will require storage and easy access.

Have sufficient space for piles that are curing, or slowly finishing the composting process. They will need to sit for several months. Have an ample supply of browns, or carbon-rich material, ready to mix with incoming greens, or nitrogen-rich material. Collecting as many fall leaves as possible and storing them for use throughout the year is a great practice. Make sure to secure the leaves from becoming a critter habitat. If you store browns in a pile, be prepared to move the pile occasionally to prevent nesting.

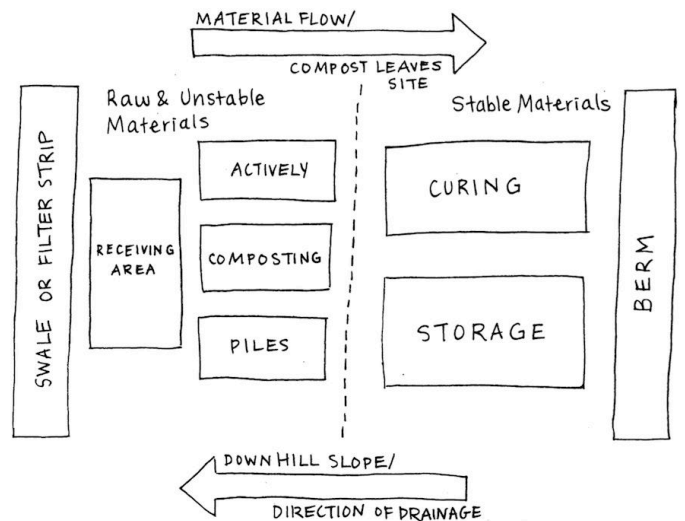

▲ The layout of a composting site should allow for a logical and efficient flow of materials and people, while minimizing the potential for contamination of more stable materials. Adapted from Oregon State University, *Agricultural Composting and Water Quality* (2013).

Some other considerations for designing your site:

- Paved surfaces work well for all steps of the composting process, particularly for feedstock mixing areas and active composting piles. Paved surfaces can also provide a flat surface on which to build compost bins or bays. If working on concrete, have a plan to manage stormwater runoff, particularly water that comes into contact with feedstocks and active piles.
- If your site is sloped, your finished or curing piles should always be upslope from any active piles to keep water from flowing through unstable material and contaminating more stable compost. If using windrows, run them downslope, so that they do not block the flow of water.
- Ideally, nothing involved in the composting process – tools, feedstocks, composting systems, active composting piles, curing or finished compost piles – should sit in standing water. Water that directly contacts actively composting materials should never run directly into surface water.
- Shaded spaces, such as beneath a tree or a roof, will help your composting piles and compost stay moist by limiting evaporation – this is also a bonus for the composters themselves as it makes composting a little cooler on a hot day. A roof has the added benefit of providing cover from inclement weather.



## PART 1 For New Composters and New Sites

- Is your site easy to access for dropping off materials? If you collect scraps from the community, provide clear rules and instructions for participation. The flipside of this is the security of the site: do you need locks to prevent untrained visitors from depositing food scraps or to secure tools? Consider using fencing, existing trees or shrubbery, or buildings to create a visual screen around the composting area. This will avoid drawing unwanted attention.
- Keep your site tidy, attractive, and free of clutter. There's a saying in the composting industry, that "people smell with their eyes."

### WATER

**Contact water** is any water that has come into contact with raw feedstocks or actively composting material and is a top management priority.<sup>9</sup> Keep contact water from running off site into surface water and food growing areas. Contact water is not compost tea; it may contain pathogens and a high-nutrient load. High-nutrient contamination in waterways causes algal blooms, which deplete the oxygen levels in the water, creating "dead zones" in which fish and other water life cannot live.<sup>10</sup>

Avoid setting up a composting site where the contact water can drain directly into stormwater drains or surface water. Contact water may harm crops as high-nutrient levels can burn the plants, in the same way as adding too much fertilizer can. Covering composting piles – with roofs,

lids, or semi-permeable fabric covers – and adding only as much water as is needed will help you control water inputs and minimize the formation of any contact water. Swales, berms, and filters, or a combination of the three, can be employed to manage **stormwater runoff**, or water that drains off of the composting site, at sites with a slope and composting piles not under a roof.<sup>11</sup>

Water that has touched curing or finished compost, or stable browns such as wood chips, is relatively harmless. However, runoff from storm events still needs to be anticipated and managed. Nothing in the composting process should ever sit in standing water for extended periods of time as this creates anaerobic conditions. Keep clean water clean!

### PESTS

**Pests** include rats, flies, cockroaches, or any unwanted animals and insects that can act as vectors of pathogens and disease. While areas adjacent to your site may contribute to the burden of managing any pests, proper site management can control them. A nearby dumpster containing wasted food will likely be a breeding ground for pests. These pests may then venture to the composting site in search of habitat. Installing a rodent resistant bin alone is not sufficient to keep pests at bay. Proper management practices – including keeping materials secure, never leaving food scraps exposed, excluding meat and dairy, preventing hiding and breeding spots, and general site hygiene – are critical to mitigation.

Wildlife species presence varies by geography. Thus, give consideration to those species found in your area. For example, while rodents are found in most urban areas, black bears are only found in portions of the United States. Contact local wildlife specialists (e.g., your state wildlife agency) to determine what species are present in your area and recommendations for preventing these species from gaining access to composting piles.

### Be a Good Neighbor

Building a relationship with the community around your composting site must be a priority. An engaged local community can be an invaluable source of support for your project, be it with labor, resources, or advocacy.



▲ BK ROT in Brooklyn uses their concrete pad to mix feedstocks by first creating a circle of carbon-rich materials, then adding wet food scraps to the middle. The carbon-rich material soaks up excess liquid. Source: *Institute for Local Self-Reliance*.

<sup>9</sup> Contact water is commonly referred to as leachate in the industry. We avoid using "leachate" due to its association with toxic leachate from landfills. Several states similarly use the term "contact water" in lieu of "leachate." See, for example, the Maryland Department of the Environment's "Permitting Guidance for Maryland Composting Facilities" (June 12, 2015).

<sup>10</sup> Robert J. Diaz, and Rutger Rosenberg. "Spreading dead zones and consequences for marine ecosystems." *Science* 321 (2008): 926-929.

<sup>11</sup> Linda Brewer, Nick Andrews, Dan Sullivan, and Will Gehr. "Agricultural Composting and Water Quality." Oregon State University Extension Service EM 9053 (2013): 7-9.

## PART 1 For New Composters and New Sites



▲ The NYC Compost Project hosted by Red Hook Community Farm in Brooklyn transitioned from bags of fall leaves, to food-grade containers to deter creating habitat for pests. The late David Buckel pictured here. Source: *Institute for Local Self-Reliance*.

Even a properly run composting system will produce some odors and may look strange to people unfamiliar with the process. Some people start from a place of fear with concerns about what composting might be. Some may even equate a composting site with a landfill. Engage your neighbors proactively to educate them about proper composting. Provide ample opportunities to share the community benefits of composting with your neighbors.

Taking neighbors on tours to see how you are managing your site, the precautions you are taking to prevent nuisance issues, and generally being available to them when they have questions will go a long way. Educational and informational signage are critical for both visitors and participants. The bottom line, however, is that for any of this outreach to be effective, your composting site must be properly managed!

Some questions to consider regarding the community surrounding your composting site:

- How will your initiative serve and include the local community?
- How familiar with and receptive to composting are your neighbors?
- Can you create a visual screen, using fencing, trees, or buildings between your composting site and your neighbors?
- If you will use loud machinery at your site, what time of the day will be best to avoid complaints?
- All composting produces some level of odors. Mixing and turning piles are times when odors can be released. Handling highly putrescible food scraps in the heat of the summer is another. When will it be best to do this to avoid complaints? Odors cannot be avoided. The key is to avoid nuisance odors.

### 3 Steps to Get Started

The previous section outlined considerations to think about before you begin composting. Once you have a site and a general management plan, you're ready to pull some tools and materials together to start building out your site! In this section, we outline three action steps to prepare for composting: (1) choose your composting system; (2) assemble your tools; and (3) select, collect, and manage your feedstocks.

#### Step 1: Choose Your Composting System

Composting systems come in many sizes, shapes, and prices. Our companion report to this guide, *Micro Composting: A Guide to Small-scale and On-site Food Scrap Composting Systems*, discusses sizing considerations, space requirements, and cost data, and shares the results of our survey of 41 small-scale compost systems. Which system you choose depends on many factors such as how much material you need or want to compost, your space and site restrictions, your budget, and your workforce (whether paid or volunteer). You can buy prefabricated manufactured systems or you can make your own.



▲ When laying out your community composting site, think through the entire composting process and designate space for each step. Make it easy for the community to participate by providing clear instructions and easy access to materials and tools. Source: *Institute for Local Self-Reliance*

The basic types of composting configurations used by community- and farm-scale operations are:

1. Turned windrows
2. Bin systems
3. Aerated static piles
4. Passively aerated static piles
5. In-vessel
6. Static piles
7. Vermicomposting (worm composting)

Turned windrows are elongated piles that can be built by hand or front-end loader. They tend not to be enclosed, though some sites may have large indoor or covered spaces that can accommodate windrows. Static piles, passively

aerated static piles (with perforated pipes to allow for natural aeration), or aerated static piles (with pipes and blowers) can be built out in the open, in bays, under roof, or in an enclosed bin system. Bin systems can be considered a type of in-vessel system, which basically refers to any system where the composting is enclosed in a building or a container.<sup>12</sup> As vermicomposting is a completely different approach to composting, we will only briefly touch on it in this guide.<sup>13</sup> No matter what system you choose, proper management is needed.

The minimum pile size for achieving thermophilic conditions is 27 cubic feet or one cubic yard (which is roughly the size of a large washing machine). Make sure your system can accommodate at least this volume of material to reduce the loss of heat and moisture from your pile and ensure the composting process can proceed without premature

<sup>12</sup> Robert Rynk, *On-Farm Composting Handbook*, Northeast Regional Agricultural Engineering Service (NRAES) Cooperative Extension, (1992): 24-37.

<sup>13</sup> For more information on vermicomposting, see Rhonda Sherman, *The Worm Farmer's Handbook: Mid- to Large-Scale Vermicomposting for Farms, Businesses, Municipalities, Schools, and Institutions* (Chelsea Green Publishing, 2018).

## PART 1 For New Composters and New Sites

interruption. Adding layers of insulation to composting bins and vessels can help small volume piles keep their heat, and may be helpful in colder seasons and climates.

For community-based composting projects in urban areas or other places where rodent pressure is high – particularly where volunteers make up most or all of the labor force – the use of enclosed bin or in-vessel systems may be beneficial. Enclosed systems, such as tumblers and bins wrapped in ¼-inch hardware cloth, can help keep pests like rats and mice out. If the systems are raised off the ground and have sufficient air vents, they can help air to circulate

and prevent liquid from accumulating at the bottom of the pile.

Piles in bin systems can be either actively aerated with blowers, passively aerated, or static with regular turning. If they are well designed and built, bin systems can help keep the process tidy and last for many years. Multiple-bin composting systems are designed to facilitate several stages of decomposition. When the first bin is full of new material or is filling up, the other bin(s) can be composting or curing. Plastic bin systems limit airflow, so additional care is needed: choose a system with air vents, mix the material regularly, add sufficient browns to your recipe, and do not overwater.



▲ The addition of a blower converts this otherwise passively aerated static pile into an aerated static pile at ECO City Farms in Edmonston, Maryland. *Source: Institute for Local Self-Reliance.*



▲ The NYC Compost Project hosted by BIG Reuse located under the Queensboro Bridge uses a GORE® cover to convert an otherwise aerated static pile into an in-vessel composting system. *Source: Institute for Local Self-Reliance.*



▲ In 2016, ILSR built Real Food Farm in Baltimore a 5-bin Compost Knox composting system by Urban Farm Plans. *Source: Institute for Local Self-Reliance.*



▲ A Green Mountain Technologies Earth Tub at the New York Harbor School on Governors Island. *Source: Institute for Local Self-Reliance.*

## PART 1 For New Composters and New Sites

For a more in-depth discussion of small-scale composting systems, including some general cost estimates, see:

[Micro-Composting: A Guide to Small-scale and On-site Composting Systems](#) (ILSR), and [Community-Scale Composting Systems: A Comprehensive Practical Guide for Closing the Food System Loop and Solving Our Waste Crisis](#) (Chelsea Green Publishing, 2019).

### COVER YOUR COMPOST

Roofs, lids, or impermeable tarps are a good way to keep your composting pile and compost from getting waterlogged, anaerobic, and smelly. **Selectively permeable fabric covers** or **biocovers** reduce moisture loss from piles and help keep odors down and animals out of your compost. Selectively permeable covers are fabric covers used to protect actively composting piles, curing piles, and finished compost piles by shedding rainfall but still allowing piles to breath. Biocovers are thick layers of compost or carbon-rich material, such as wood chips, used as natural air filters to cover actively composting piles. Using a nice thick layer of wood chips, mulch, or other carbon-rich material at the base of your pile will also help soak up any extra moisture and keep your site cleaner and drier. Managing odors and never leaving any exposed food scraps are key to avoiding pests.

---

*Managing odors and never leaving any exposed food scraps are key to avoiding pests.*

It is possible to build compost piles out in the open, even in urban areas. For example, the NYC Compost Project hosted at Red Hook Community Farm in Brooklyn successfully uses the windrow method. However, this requires meticulous management to assure pests are not attracted to composting piles or other materials stored around the site. Red Hook uses thick layers of more mature compost as biocovers to “seal” fresh windrows being built with incoming food scraps. They have developed a procedure in which freshly built windrows are covered with a layer of mature compost a foot deep. As the composting pile matures the thickness of the biocover is reduced to 6 inches.

Biocovers made of mature compost serve several purposes:

- Act as biofilters, filtering odors and reducing the attraction of pests,
- Retain heat and minimize loss of moisture,
- Reduce losses of carbon and nitrogen to the air via volatilization, and
- Inoculate new piles with microorganisms to jump start the decomposition process.

For any system that is not otherwise enclosed, it is of particular importance to fully cap active composting piles with a selectively permeable cover or a biocover, such as a layer of at least 2 inches of screened compost or at least 6 inches of unscreened compost, to ensure food scraps are adequately covered and not visible. Twelve inches of composting overs can also be used as a biocover.<sup>14</sup> **Overs** are materials screened out of finished compost; they tend to be lignin-rich materials such as wood chips that have not fully broken down in one pass through the composting process. Compost covers are important for managing odor and unwanted fly problems even in enclosed bin systems, but in open piles they are the only protection from unwanted critters.

---

*Compost covers are important for managing odor and unwanted fly problems even in enclosed bin systems, but in open piles they are the only protection from unwanted critters.*

### LOCATING YOUR SYSTEM

Below are some tips for locating your composting system, with a special focus on avoiding rodents. Many of these practices will also help prevent other animals from being attracted to your composting piles.

Here are some tips for locating and managing your system:

- Pick a dry spot that is easy to access, but isn't in the way. Avoid spots that puddle or hold water after a rain. Wet conditions need to be carefully managed as they can create anaerobic conditions, which can lead to odors.

<sup>14</sup> U.S. Composting Council, *Compost Operations Training Course* (2015).

## PART 1 For New Composters and New Sites

- Place your composting system as far away from any dumpsters or trash cans as possible, or at least make sure that trash cans are well sealed – something we should all do anyway!
- Rodents do not like to feel exposed, so don't give them places to hide! Avoid clutter, piles of materials, tall grasses, and low shrubs around your composting system. If piles of materials are unavoidable, move them around periodically. Rodents prefer habitats that are not disturbed. Activity is your friend.
- Ensure a clutter-free minimum 2-foot buffer between your composting system and exterior walls, fences, shrubs.<sup>15</sup> A minimum 3-foot buffer is needed around sidewalks, building foundations, concrete slabs, and footings as these provide rodents particularly safe burrowing spaces.<sup>16</sup> Keep this buffer area clear at all times.
- Set up your system, including the clutter-free buffer zone, on a paved or gravel surface in order to prevent animals from burrowing underneath. A gravel pad should be at least 6 inches deep and use 1-inch-diameter or larger stones. If on a paved surface, add an additional strip of gravel 2 feet wide around its edge.
- If you have to place the system directly on the ground, consider using paver stones or hardware cloth to line the inside bottom of the system. Monitor for and fix any gaps or holes immediately.
- Always cap exposed piles with either a selectively permeable cover, at least 2 inches of screened compost, at least 6 inches of unscreened compost, or 12 inches of compost overs. Piles in enclosed bins should also be capped so that no food scraps are visible. This will reduce odors, avoid flies, and keep from attracting rodents.

### Step 2: Assemble Your Tools

Now that you have a site design and system in mind, it's time to assemble your site and get your tools and equipment together. Regardless of your scale and level of management, you will need some basic supplies and tools such as buckets to collect or measure materials, a pitchfork and shovel

for mixing and moving material, and shears or a sidewalk ice scraper to chop up big materials. If you opt for hot composting, get a temperature probe (available for around \$30<sup>17</sup>) along with a binder for tracking data. You will also need a dry, secure space to store your tools that still provides easy access for participants.

---

*Always cap exposed piles with either a selectively permeable cover, at least 2 inches of screened compost, at least 6 inches of unscreened compost, or 12 inches of compost overs. Piles in enclosed bins should also be capped so that no food scraps are visible.*

### Step 3: Select, Collect, and Manage Ingredients

Determine what green or high-nitrogen materials you have available, how you will collect them, and how much your chosen system can handle. Know the total capacity of your composting system and your site.<sup>18</sup> Think of this in terms of how much material your system can manage on a weekly or monthly basis. Also consider the capacity of your site



▲ The NYC Compost Project hosted by Red Hook Community Farm is a leader in best management practices for urban community composting. Volunteers pose with a 4-ton, hand-built windrow that is sealed with a thick biocover of mature compost. Source: David Buckel.

15 Caroline Bragdon, "The Lives and Habits of Rats" (2017). View this presentation and the rest of ILSR's webinar on *Successful Rat-Prevention for Community Composting* at <https://ilsr.org/successful-rat-prevention-for-community-composting-webinar/>

16 Internet Center for Wildlife Management, "Rodent-Proof Construction and Exclusion Methods", <http://icwdm.org/handbook/rodents/RodentExclusion.asp> (accessed December 2018).

17 Temperature probes for both small and large composting piles can be purchased at <https://reotempcompost.com/backyard-compost-thermometer/>.

18 For detailed information on sizing composting systems, see James McSweeney, *Community-Scale Composting Systems: A Comprehensive Practical Guide for Closing the Food System Loop and Solving Our Waste Crisis* (Chelsea Green Publishing, 2019).



### SPOTLIGHT - Vermicomposting

Vermicomposting is a method of composting that depends primarily on earthworms to drive the process. But, not just any earthworms will do. Of the over 9,000 identified earthworm species, only 7 consume food scraps. Epigeic worms, or worms that live in leaf litter on top of the soil, are the type of earthworms that can be used for vermicomposting. *Eisenia fetida*, also known as the red wiggler, is the most commonly used species for vermicomposting in North America.

The product of the vermicomposting process, known as “vermicompost” or “vermicast,” is a substance rich in plant-growth hormones, humus, and humic acids. Humus and humic acids are the waste products of microorganisms that are present in vermicompost, but are usually only found in very old, healthy soils. These benefits are attributed to a relatively high microbial diversity (as compared with thermophilic compost), which comes from materials passing through the digestive system of worms. Because of this, a cubic yard of vermicompost may be sold for as much as 10 times more money than regular compost.

Though they are both methods for managing organic residuals in a way that creates a valuable end product, thermophilic composting and vermicomposting are different processes. Let’s start with the similarities. Both require aerobic conditions and need the right balance of carbon and nitrogen. Vegetable and fruit scraps, coffee grounds, and eggshells are still acceptable feedstocks – though you will need to chop everything into smaller pieces. Biocovers are critical in vermicomposting as in thermophilic composting – but you will more likely be using shredded newspaper, cardboard, or leaves. A base of moistened carbon, like shredded newspaper or leaves, will act as the bedding for the worms.

Vermicomposting is all about the worms! Worms are more particular about what they will eat than our hot composting microbes (nothing too salty or acidic). Worms also need a higher moisture content – 70 to 90 percent moisture, whereas thermophilic composting aims for 50 to 65 percent. Instead of building a pile, vermicomposting is all about surface area, as the epigeic worms that eat food scraps live in their bedding and feed on its surface. Add only 1- to 2-inch layers of food on top of the vermicomposting system at one time, and no more until

the worms have consumed that layer. Worms need a more stable temperature range, preferring to remain between 40 to 80°F.

Similar to thermophilic composting, avoiding contamination and pathogens are priorities. They are addressed through proper management and maintaining aerobic conditions in your system. A best management practice in the commercial vermicomposting industry for avoiding pathogens involves pre-composting – or first putting materials through the hot composting process and allowing it to go through the thermophilic phase before adding it to the vermicomposting system.



▲ ECO City Farms’ Benny Erez shows off his healthy worms. Source: Chris Cano.

For those interested in learning more about vermicomposting, Rhonda Sherman, Extension Specialist at North Carolina State University, is a great resource: <https://composting.ces.ncsu.edu/vermicomposting-2/>. She hosts an annual Vermicomposting Conference and recently authored *The Worm Farmer’s Handbook: Mid- to Large-Scale Vermicomposting for Farms, Businesses, Municipalities, Schools, and Institutions* (Chelsea Green Publishing, November 2018). Also see ILSR’s January 2019 recorded webinar with Rhonda, *Composting with Worms on a Mid to Large-Scale — What, Why, How, and Who* (<https://ilsr.org/webinar-vermicomposting-january-2019/>).

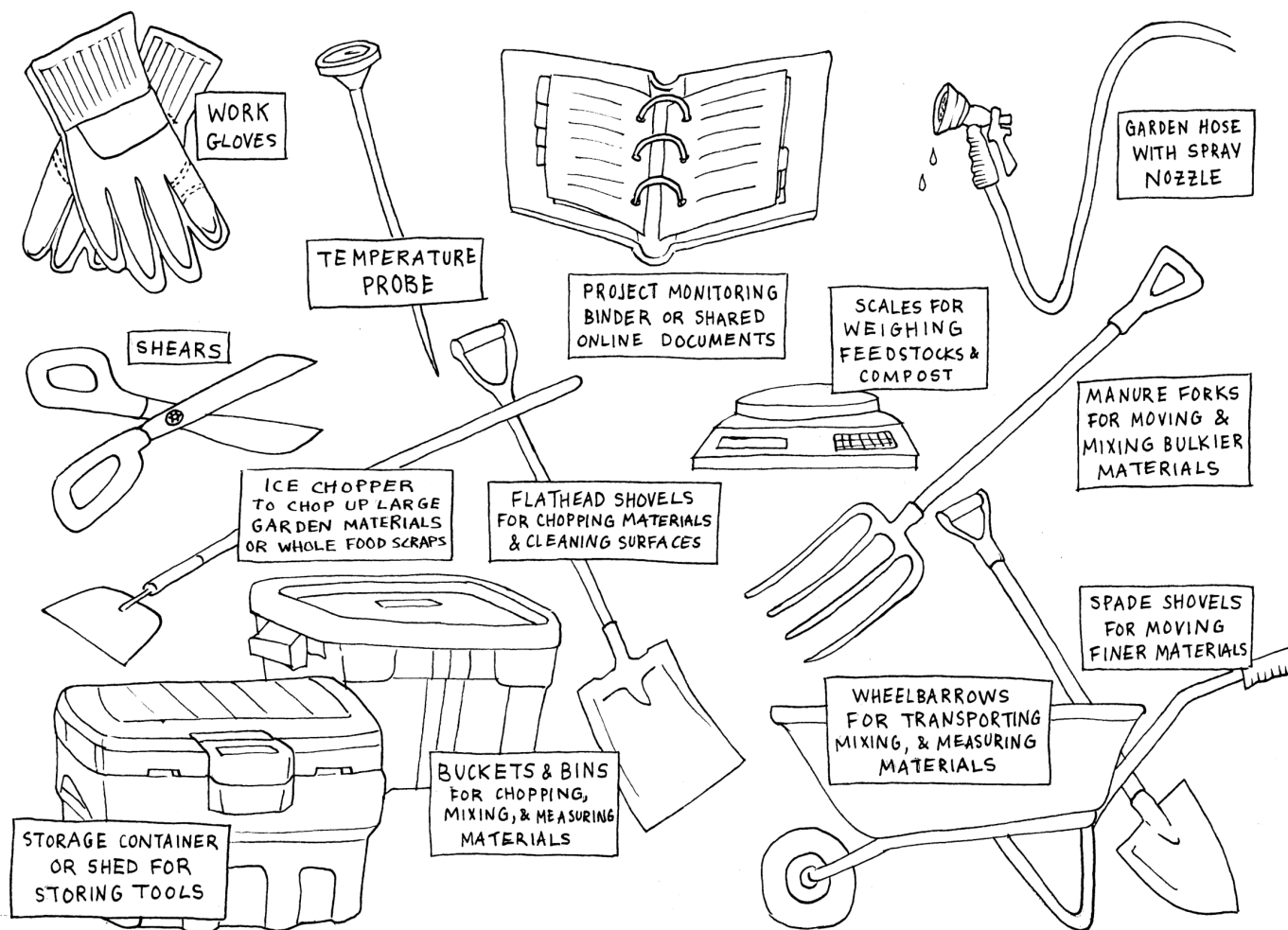

▲ The basic tools of community composting. Source: Institute for Local Self-Reliance

for storing browns, which you will need to have readily available on an ongoing basis. How much room is left after space is allocated for actively composting piles, curing piles, and storage of finished compost, browns, and tools?

### *Know the total capacity of your composting system and your site.*

Do you want to provide neighbors with 5-gallon buckets or small pails to collect leftover fruit or veggie scraps from their kitchens? If so, how will you manage this? In DC, for example, the DC Department of Parks and Recreation operates more than 50 compost cooperative sites. Members of each cooperative can drop off and compost their own food scraps in a 3-bin system; participation is free. In order to have this access, they must join the cooperative, take a 1-hour training, and agree to work 1

hour a month for 9 months out of the year. They use their own containers.<sup>19</sup> Another option is to charge members a minimal fee – say \$40 per year – to join and earn the right to drop off. Both options also provide a list of folks to tap for work days for sifting, turning piles, and general management.

Can coffee and coffee filters be collected from a local coffee shop? Perhaps you want to start a business and use a bike or truck to collect from the community for a fee. The materials you target for collection should be guided by your goals, the human labor you have available, and the capacity of your system.

Will you allow participants to drop off material at your site? If yes, provide clear rules for how they participate. Consistent and regular days and times for community participation will facilitate maximum engagement. Ensure drop-off bins are clearly labeled and rodent resistant, such

<sup>19</sup> For more information on the DC Department of Parks and Recreation's Community Compost Cooperative Network, visit <https://dpr.dc.gov/page/community-compost-cooperative-network>.



## PART 1 For New Composters and New Sites

as an off-the-ground tumbler or a metal bin with ¼-inch or smaller holes drilled in the sides and bottom, and a securely closing lid. No overflow of food scraps should be allowed and all materials need to be secured from pests.

*No overflow of food scraps should be allowed and all materials need to be secured from pests.*

### GREENS

Manage putrescible materials such as food scraps with particular care. Ideally incorporate them into the composting process immediately. Unlike carbon-rich materials, food scraps should not be stored onsite. One exception is bokashi-fermented food scraps. (**Bokashi** is a Japanese term meaning “fermented organic materials.”<sup>20</sup>) If they must be stored and fermentation is not possible, immediately mix the food scraps with enough browns to soak up any liquid and prevent anaerobic conditions and secure from unwanted pests. (Anaerobic conditions are an oxygen-deprived environment, which can lead to odors.) If your collection system is separate from your composting system, set and maintain a consistent schedule to manage it in addition to composting process maintenance.

Unlike programs that collect food scraps for off-site composting at large-scale sites, not all small-scale composting systems can handle all types of food scraps. Meat, cooked food, dairy, grease, and oil should be specifically excluded, except at sites where attentive management from an experienced operator is involved. These particular materials are more likely than fresh veggie and fruit scraps to foster anaerobic conditions and produce odors that can attract pests and annoy neighbors. You can tell participants the site is “fat-free and vegan.” For larger, more experienced sites wanting to include grease, oils, and dairy, the U.S. Composting Council recommends limiting this material to no more than 5 percent of the total volume.<sup>21</sup>

Animal manures such as chicken litter or hamster bedding are not recommended for new composters or sites that are not achieving temperatures above 131°F, as they are a potential source of pathogens. That said, in the hands of an experienced composter and as part of a well-balanced compost recipe, animal manures and bedding can help achieve these high temperatures. On farms where animal manure is plentiful, composting can be a good management strategy.

For compost that will be used immediately on land currently growing food for human consumption, animal manures must be composted with active management involving regular monitoring of temperatures and



▲ Informational signage at Prospect Heights Community Garden's food scrap drop-off.  
Source: Institute for Local Self-Reliance.



▲ The food scrap drop-off can at Prospect Heights Community Garden in Brooklyn.  
Source: Institute for Local Self-Reliance.

20 For more information on bokashi as a pre-treatment for composting, see ILSR's April 2018 webinar, *Using Bokashi in Community Composting – What, Why, How, Who*, available online at <https://ilsr.org/webinar-bokashi-april-2018/>.

21 Eva Christensen, *Best Management Practices (BMPs) for Incorporating Food Residuals Into Existing Yard Waste Composting Operations* (U.S. Composting Council, 2009).

## PART 1 For New Composters and New Sites



▲ Informational signage guides drop-off participants at Real Food Farm in Baltimore. Source: Institute for Local Self-Reliance.



▲ New members of the community food scrap drop-off at Real Food Farm are trained. Source: Institute for Local Self-Reliance.



▲ Domingo Medina of Peels & Wheels Composting collects food scraps from residences, small businesses, and schools by bike in New Haven, Connecticut. Source: Peels & Wheels Composting.

achieving Process to Further Reduce Pathogens (PFRP) requirements (see page 45 for more on PFRP). Both raw manure and compost that is made with manure but is not actively managed, may still be used on land that is fallow or not currently growing crops for human consumption. Organic agriculture standards require certain time intervals between application and crop harvest (120 days for crops like salad greens, 90 for crops like tomatoes).<sup>22</sup> The U.S. Food and Drug Administration is reviewing whether it should restrict the use of raw manures altogether.<sup>23</sup> Farmers should also be aware of existing nutrient management regulations in their states, which may limit the amount of compost or manure that can be applied.

*Unlike programs that collect food scraps for off-site composting at large-scale sites, not all small-scale composting systems can handle all types of food scraps. Meat, cooked food, dairy, grease, and oil should be specifically excluded, except at sites where attentive management from an experienced operator is involved.*

22 Composting Association of Vermont (COV), "For Certified Organic Production," <http://compostingvermont.org/about-composting/compost-for-certified-organic-production/> (accessed March 2019).

23 U.S. Food and Drug Administration, "Raw Manure Under the FSMA Final Rule on Produce Safety," <https://www.fda.gov/food/guidanceregulation/fsma/ucm482426.htm> (accessed February 2019).

## PART 1 For New Composters and New Sites



▲ Browns storage at Sunshine Community Compost in Sarasota, Fla. Source: *Institute for Local Self-Reliance*.



Browns storage at Red Hook Community Farm in Brooklyn. Red Hook is a leader in community composting best management practices. Source: *Institute for Local Self-Reliance*.

### BROWNS

Having an adequate supply of carbon-rich material on hand is essential when composting wet and putrescible food scraps. Unlike high-nitrogen green materials, browns can and should be stored onsite in some manner. Utilizing a blend of browns can create ideal conditions for composting microbes to thrive (see next step). From where will you source carbon-rich brown materials? How will you ensure an adequate supply onsite? Prepare a recipe of browns and have it ready to add to greens when the time comes (see pages 33-34 for a sample browns mix recipe).

---

*Piles of browns or finished compost with no recognizable food scraps can still be tempting for pests to nest in. Don't let pests contaminate your hard-earned black gold!*

Even non-putrescible materials such as leaves and wood chips require proper storage to avoid becoming an eyesore or home for critters. In locations with either strong pest pressure or problems with unwanted dumping, all storage units should be adequately secured. Piles of browns or finished compost with no recognizable food scraps can still be tempting for pests to nest in. Don't let pests contaminate your hard-earned black gold! Properly sealed and fastened lids, bungee cords, combination locks, and other devices can be used to secure enclosures. If you keep your browns in open piles, move the piles around periodically, so they don't become a hospitable home for animals.



### SPOTLIGHT - A Word About Compostable Products and Paper

Beginning composters may want to avoid compostable plastics, packaging, and foodservice items as these materials can be more tricky to manage and compost. For one, they often need to be size-reduced to biodegrade (such as tearing clamshells or paper cups into smaller pieces). Secondly, not all products labeled as compostable or biodegradable meet certification standards. Unless you work directly with foodservice entities to ensure they only procure certified compostable products, you may run into contamination issues. Not all compostable plastics are created equal. Require food scrap generators to only use products certified as compostable by the Biodegradable Products Institute (BPI).<sup>a</sup>

One relatively new issue of concern for composters is a family of chemicals known as per- and polyfluoroalkyl substances (PFAS), some of which are known to be toxic and bioaccumulative. Food, water, and packaging are sources of PFAS found in humans. Biosolids and paper mill residuals have been found to have PFAS, which have turned up in biosolids compost (and also in smaller concentrations in

compost made in part from food scraps). Due to the growing environmental concerns around these fluorinated chemicals, BPI will be restricting and eventually eliminating fluorinated chemicals from its compostable products certification by the end of 2019.<sup>b</sup> Based on this emerging and serious concern, community composters may want to reject paper and compostable foodservice items until products are certified as PFAS-free.

Compostable plastic bags used as bucket or toter liners for food scrap collection can help remove the “ick” factor for participants. Again, only use certified compostable products and be especially wary of bags labeled as “biodegradable,” which often are a type of oxo-degradable plastic that breaks down into small pieces but does not compost. In contrast, bags carrying the home compostable mark (by a European company) in addition to BPI’s compostable certification, have the added advantage of composting at mesophilic temperatures.<sup>c</sup> Be sure to empty contents of all compostable plastic bags before adding to the process. Tearing bags into a few pieces can speed decomposition. And always make sure the bags are incorporated into the pile so that they don’t blow away, becoming an eyesore.

a For more information on certified compostable products, visit the Biodegradable Products Institute website at [www.bpiworld.org](http://www.bpiworld.org).

b Biodegradable Products Institute, “Position on Fluorinated Chemicals” web page, <https://bpiworld.org/Fluorinated-Chemicals>, (accessed December 2018). Also see, Ned Beecher and Sally Brown, “PFAS And Organic Residuals Management,” *BioCycle* (July 2018) Vol. 59, No. 6, pg. 20.

c Belgian certifier TÜV Austria Belgium has developed a OK compost home certification mark. It requires at least 90% degradation in 12 months at ambient temperature. See “What are the required circumstances for a compostable product to compost?” at <https://www.european-bioplastics.org/faq-items/what-are-the-required-circumstances-for-a-compostable-product-to-compost/>.

# YES! ✓

# NO! ✗

## GREENS

**FRESH VEGETABLE & FOOD SCRAPS**  

**EGG SHELLS**  
 Crush them up!  



**CUT FLOWERS & GREEN LEAVES**  



**COFFEE GROUNDS & FILTERS, TEA BAGS**  
 Paper filters & bags, no staples  



**MOST GARDEN WASTE**  
 Avoid aggressive weeds & grasses  



**GRASS CLIPPINGS**  
 Not treated with pesticides  



## BROWNS

**DRY LEAVES**  

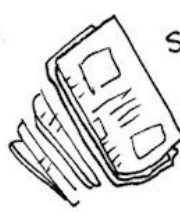

**WOOD CHIPS**  
 Untreated  

**WOOD SHAVINGS**  
 Untreated  

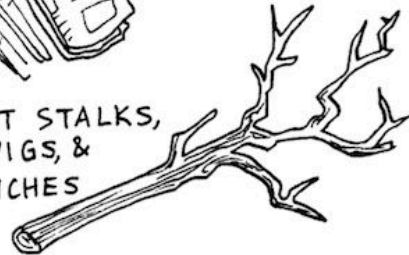

**STRAW**  
 Untreated  



**SHREDDED NEWSPAPER**  

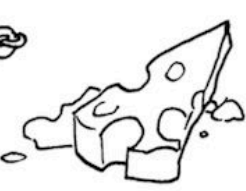

**PLANT STALKS, TWIGS, & BRANCHES**  



**COOKED FOOD**  



**CHEESE & DAIRY**  



**MEAT & BONES**  

**OILS & GREASE**  



**DISEASED PLANTS**  

**POISONOUS PLANTS**  

**GLOSSY OR COATED PAPER**  

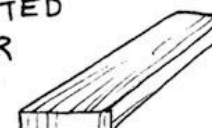
**PRODUCE STICKERS**  

**TREATED OR PAINTED WOOD**  

**PET WASTE**  

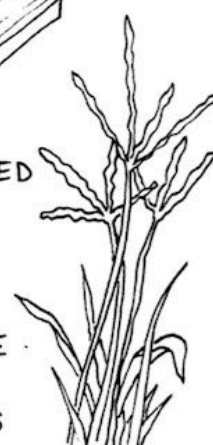
**AGGRESSIVE WEEDS & GRASSES**  

▲ Certain materials can be problematic for new composters and sites that lack active management. Meat, dairy, oil, grease, and pet wastes should be avoided in these cases. Diseased or poisonous plants and aggressive weeds are good to avoid, particularly where compost will be used in vegetable gardens. Treated wood and glossy papers may contribute unwanted chemicals. Produce stickers and other pieces of plastic or metal will need to be removed eventually. Source: *Institute for Local Self-Reliance*



## Part 2: The Science and Art of Composting

Regardless of the size of the composting operation, our composting piles will require the same basic inputs (microorganisms, food, air, and water) and produce the same basic outputs (more microorganisms, water, stable **organic matter**, and nutrients). Heat, water vapor, and carbon dioxide are other byproducts. Fundamentally, composting transforms raw, unstable organic materials into stable organic matter: **compost**.

Part 1 of this guide covered the basics of composting and considerations for preparing to compost. In Part 2, we take a deep dive into the composting pile to explore important composting science principles. We begin by exploring the science behind developing a good composting “recipe.” We then look more closely at the characteristics of a well-structured composting pile and how to build one.

### Determine Your Composting Recipe

Our composting microbes need a balanced diet of carbon and nitrogen as well as sufficient water and air to thrive. To accommodate their needs, be intentional about the “ingredients” or feedstocks you feed them. Before building a pile, create a composting recipe based on available feedstocks. Certain feedstocks provide microbes their food, and some provide needed moisture – though additional moisture may be necessary for drier feedstocks and as composting proceeds. Still other feedstocks can be added to absorb

▲ Jesse Williams of Rust Belt Riders unloads food scraps collected in the Cleveland area. Source: Jacob Koestler.

## PART 2 The Science and Art of Composting

excess moisture or give your pile a good structure. Your recipe should create a mix that is neither too dense nor too light, and allows air to flow throughout your pile. This section outlines considerations for designing your composting recipe.

### Food

Choose feedstocks that will act as a source of food for our composting microbes. Carbon and nitrogen are the most important nutrients for the composting process. To provide these nutrients in the right proportions, different feedstocks often need to be mixed together. There are a couple of methods to decide how many volumetric “parts” of each feedstock should be mixed together to provide the needed carbon and nitrogen. Method 1 is an easy, fast, and less precise estimation of the ratio of carbon and nitrogen in our final mix. Method 2 can be more informative and involves calculating the ratio of total carbon to total nitrogen of the feedstocks and adding them together.

#### METHOD 1: THREE PARTS BROWNS TO ONE PART GREENS

A quick rule-of-thumb for new composters is to use the same size container, such as a wheelbarrow or bucket, to measure three parts by volume of brown materials to one part by volume green materials. As discussed previously, “browns” are relatively carbon-rich materials (such as fall leaves, straw, and wood chips) and “greens” are relatively nitrogen-rich materials (such as fruit and vegetable scraps, coffee grounds, and garden trimmings). If your composting pile is not heating up as much as you would like, try adjusting this recipe to two or two-and-a-half parts by volume browns to one part by volume greens.

This browns-to-greens shortcut helps us estimate a compost mix that approximates the ideal carbon to nitrogen ratio. But, because this method is not as material-specific as Method 2, it will require composters to keep a closer eye on things in case adjustments are needed.

#### METHOD 2: CALCULATING C:N RATIOS

The **carbon-to-nitrogen (C:N) ratio** is the proportion of the dry weight of carbon to the dry weight of nitrogen in a given material. All organic materials contain some amount of carbon and nitrogen and, therefore, have a C:N ratio. This ratio for a given material is determined via laboratory analysis. Lists of general C:N ratios for feedstocks are available.

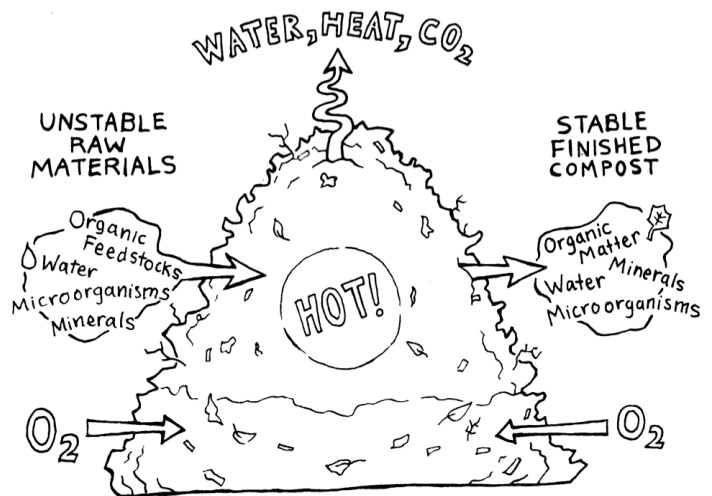

▲ Regardless of scale, the composting process requires particular inputs and produces certain outputs. Source: Adapted from Benny Erez, “The Composting Process”, Neighborhood Soil Rebuilders Composter Training Program.

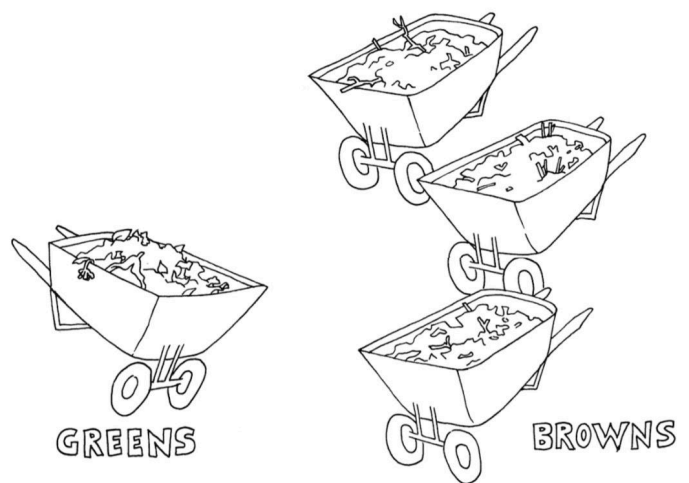

▲ A good starting recipe for new composters is to use the same size container, such as a wheelbarrow, to measure three parts by volume of brown materials to one part by volume green materials. Source: Institute for Local Self-Reliance

## PART 2 The Science and Art of Composting

### Balancing High-Nitrogen Materials with High-Carbon Materials

The C:N ratio is calculated using the following equation:

$$\text{C:N ratio} = \frac{\text{Weight of C}}{\text{Weight of N}}$$

(on a dry weight basis)

where C is the element carbon and N is the element nitrogen

The ideal C:N ratio for an initial compost mixture is between 20:1 and 40:1, with a target of 25:1 to 30:1

Instead of using complicated formulas, you can use this rule of thumb:

Three buckets of high-carbon materials to one bucket of high-nitrogen materials to approximate a C:N ratio of 30:1.

TABLE 1. GREENS: HIGH-NITROGEN MATERIALS

Materials High in Nitrogen	C:N Ratio (range)	C:N Ratio (average or typical)
Chicken manure (laying hens)	3 - 10	6
Coffee grounds		20
Food scraps		15
Grass clippings	9 - 25	17
Horse manure	22 - 50	30
Vegetable trimmings		25

Source: Robert Rynk, editor, *On-Farm Composting Handbook*, by Natural Resource, Agriculture, and Engineering Services (NRAES) Cooperative Extension (June 1992), pp. 106-113; and Washington State University ([http://whatcom.wsu.edu/ag/compost/fundamentals/needs\\_carbon\\_nitrogen.htm](http://whatcom.wsu.edu/ag/compost/fundamentals/needs_carbon_nitrogen.htm))

To come up with a recipe for your composting mix, you can look up the C:N ratio and average moisture content for each individual feedstock you plan to utilize, estimate the dry weight equivalent of each feedstock material, then calculate the C:N of the total mix. There are specific formulas for calculating a final C:N ratio for the whole mix.<sup>24</sup> The ideal C:N ratio for an initial composting mixture is between 20:1 and 40:1, with a target of 25:1 to 30:1.<sup>25</sup>

Average C:N ratios for individual feedstocks types can be looked up online or in composting field guides and used for approximate calculations. Several universities and local governments make these calculators available for free. Klickitat County, Washington, has an easy-to-use calculator that estimates both C:N ratio and moisture content: <https://www.klickitatcounty.org/1030/Compost-Mix-Calculator>.

The NRAES *On-Farm Composting Handbook* and associated *Field Guide to On-Farm Composting* also provide easy-to-read tables and standard formulas to assist in compost recipe making.

Laboratories can determine exact C:N ratios for composting feedstocks by analyzing the total carbon and total nitrogen in any given material sample. With this

TABLE 2. BROWNS: HIGH-CARBON MATERIALS

Materials High in Carbon	C:N Ratio (range)	C:N Ratio (average or typical)
Corn cobs	56 - 123	98
Corn stalks	60 - 73	
Corrugated cardboard		563
Hay	15 - 32	
Leaves	40 - 80	54
Newsprint	398 - 852	
Sawdust	200 - 750	442
Shrub trimmings		53
Straw (wheat)	100 - 150	
Tree trimmings		16
Woodchips	40 - 100	

Source: Robert Rynk, editor, *On-Farm Composting Handbook*, by Natural Resource, Agriculture, and Engineering Services (NRAES) Cooperative Extension (1992): 106-113.

<sup>24</sup> See, for example, page 20 of the NRAES *On-Farm Composting Handbook* for detailed sample calculations.

<sup>25</sup> Robert Rynk, *On-Farm Composting Handbook*, Northeast Regional Agricultural Engineering Service (NRAES) Cooperative Extension, (1992): 8.



## PART 2 The Science and Art of Composting

information, composters can develop very targeted compost recipes. Given that lab tests can be expensive, and that calculating C:N ratios can be complicated and overwhelming for new composters and small-scale site operators, we recommend using the rule of thumb described in Method 1 above as a starting place. This rule of thumb often results in a mix within the ideal range of 25:1 - 40:1 carbon to nitrogen ratio on a dry weight basis. As you practice the art of composting and become familiar with your feedstocks, adjust your recipe! Trial and error is part of composting. Tables 1 and 2 show C:N ratios for common composting feedstocks.

### Water

Adequate moisture is essential for composting microbes to thrive and for the composting process to proceed. The bacteria and fungi that drive the process live in a water layer around the organic particles, and rely on that water to transport dissolved nutrients needed for their metabolic activities.<sup>26</sup> The ideal moisture range is from 50 to 60 percent by weight.<sup>27</sup> Composters using active aeration (aerated static piles or ASP systems), will want to aim for 60 to 65 percent moisture in their initial pile.<sup>28</sup> Another way to think about this is that we want slightly more than



▲ Earth Matter's browns recipe, courtesy of Earth Matter NY, Governors Island, New York City. Source: *Institute for Local Self-Reliance*.

### Bioavailability of Carbon

Another factor to take into account in your composting recipe is the **bioavailability** of carbon, or how easily our composting microbes can consume and biodegrade the carbon. The carbon in leaves and sawdust, for example, is more available to biodegradation than the carbon in wood chips, which are higher in tough lignin. Screening out wood chips at the end of the composting process is normal. However, this is an indication that not all the carbon from the wood chips was consumed. Depending on your other sources of carbon, you may need to adjust your starting C:N ratio to have more available carbon. Though wood chips are hard to break down – particularly in small-scale, quick turnover systems – they are great for adding structure and air space to a pile.

half of the weight of our composting mix to come from water, whether it is present in the feedstocks or is added. When the moisture content is too low, there is not enough water for microbial life to proliferate. Below 45 percent moisture, microbes die or go dormant. Excessive moisture is also problematic, as water can fill up all of the available air spaces. This can lead to waterlogging and result in anaerobic conditions that can smell and release methane. Above 70 percent moisture, the compost pile can get waterlogged and drown aerobic, or oxygen-requiring, microorganisms.

### Air

Airflow is one of the most important factors to manage for successful composting because it is an aerobic process. A good composting recipe will take into account the density of the final mix of feedstocks. Heavy, dense feedstocks must be balanced with lighter, bulkier feedstocks. **Bulk density** is a measurement used to estimate **porosity**, or the volume of free air space in a material or mix of materials. In composting, bulk density can help estimate the potential for airflow in a pile. Certain brown materials serve as bulking agents that decrease density and increase

26 C Liang, KC Das, and RW McClendon. "The influence of temperature and moisture contents regimes on the aerobic microbial activity of a biosolids composting blend." *Bioresource Technology* 86 (2003): 131-137.

27 Robert Rynk, *On-Farm Composting Handbook*, Northeast Regional Agricultural Engineering Service (NRAES) Cooperative Extension, (1992): 9.

28 Peter Moon, "ASP Composting: Applications and Opportunities" (2019).

### A Word About Particle Size

Microorganisms work on the surfaces of the materials, breaking them down during composting. When a mass of material is broken into smaller pieces, it increases the available surface area. We can help microorganisms and other decomposer organisms do their job by chopping up food such as whole apples and corn cobs. Cut large garden stalks or branches to about 6 inches in length, or roughly the size of your hand. Smaller pieces of food scraps and carbon materials process faster and more completely than larger pieces, reducing the chance of attracting pests.

At the same time, using only fine-grained ingredients to build your pile (such as coffee grounds, wood shavings, and ground food scraps) will lead to a pile that lacks porosity or is too dense, creating anaerobic conditions. Make sure to balance smaller sized ingredients with bulking materials like wood chips or straw.

air space. A **bulking agent** is something that improves structure and increases porosity (adds space for air) in a pile. Wood chips are a good example.

One blend of browns ideal for mixing with food scraps, courtesy of the NYC Compost Project hosted at Earth Matter NY, is:

- 3 parts leaves,
- 2 parts wood chips or chopped plant stems, and
- 1 part wood shavings or sawdust.

These materials can be mixed together and stored onsite. (Use the suggestions for storing browns outlined in the previous section.) If using Method 1 for estimating the ratio of carbon to nitrogen, add two to three parts of this browns mix to every one part green material to create your initial composting pile.

## Building Your Composting Pile

After you have collected your feedstocks and decided on your composting recipe, you're ready to measure out your "ingredients" and get cooking! Use the same volume container – whether a 5-gallon bucket, a wheelbarrow, or the bucket of a skid-steer loader or tractor – to make sure you're combining feedstocks in the right volumetric proportions. Next, it's time to build your pile and mix things up. Regardless of the composting system you employ or the scale of your operation, the basic steps of building a pile are roughly the same.

### The Basic Steps

A simple compost pile can be built using a variation of the classic lasagna layer method. This involves building a pile in layers, being careful to add browns and greens in the right volumes, and mixing your green and brown layers together along with water if needed. Below are some basic steps for building a compost pile using this method.

1. Always make sure there is a biolayer of coarse browns, like wood chips or straw, at the bottom of your pile. This layer will filter odors that attract pests, soak up liquid from the feedstocks being used, and allow air into the pile. A layer 4 to 6 inches deep is ideal.
2. Chop up large or whole feedstocks with a flat shovel or an ice scraper. Use some sort of paved surface or container for chopping food scraps so they are not left on bare ground. You can use a metal wheelbarrow or tub (like you might wash a dog in) or a 5-gallon plastic bucket. Larger operations may opt for a grinding or chipping machine.

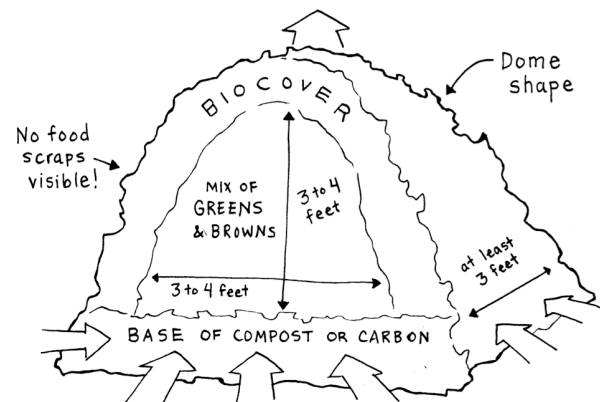

▲ A cross-section of a well-built composting pile. Source: Institute for Local Self-Reliance

## PART 2 The Science and Art of Composting

3. Add one 5-gallon bucket, wheelbarrow or tractor bucket of greens and three buckets or wheelbarrows of browns onto the base layer of browns – it's important that you use the same volume container to measure your greens and browns, particularly for new composters.
4. Ideally, you would then mix these layers together while leaving the base layer of browns undisturbed. You may use pitchforks for this, or possibly the bucket of a skid-steer loader or tractor.
5. Use your hand to check the moisture level. Your mix should feel like a wrung-out sponge. Add water if the pile is too dry by using a spray hose or hose fitted with a shower wand as you mix. However, do not overwater; water should not leak out of the bottom of the pile.
6. Repeat steps 1 through 5 as needed. You need a pile that is at least 3 feet tall, wide, and deep (a volume of 27 cubic feet or 1 cubic yard) for active composting to take place. Pile everything into a dome shape. If you can't build a pile this size all at once, keep adding material to the pile over time until it's big enough.
7. Cover your pile with a biolayer of compost or browns to keep flies out and smells down. If using a bin system, cover with 4 to 6 inches, and ensure that no food scraps are visible. When large amounts of fresh food scraps are added to an open pile, cap the pile with 6 inches of unscreened compost or a foot of composting overs.

### Achieving a Thorough Initial Mix

Step 4 above hints at the importance of mixing feedstocks together as you build your composting pile. Thoroughly mixing feedstocks at the beginning speeds along the composting process and creates a better finished product with less chance for nuisance issues. It also reduces the amount of handling and labor needed later in the process via turning and sifting.

Smaller operations or projects dedicated to avoiding fossil fuel use in their operations may opt to do this with pitchforks and some elbow grease. Red Hook Community Farm in Brooklyn, for example, builds and remixes 4-ton windrows with a team of well-choreographed volunteers.<sup>29</sup>



▲ Youth employees of the Baltimore Compost Collective add food scraps to the middle of a ring of carbon, a technique learned from BK ROT in Brooklyn, New York. Source: Michael Dorsey.

One mixing approach involves first creating a ring of brown materials, adding wetter green materials like food scraps in the middle, and then mixing everything together. The ring of browns helps to absorb any excess liquid and contains any round food scraps from rolling away.

---

*Thoroughly mixing feedstocks at the beginning speeds along the composting process and creates a better finished product with less chance for nuisance issues. It also reduces the amount of handling and labor needed later in the process via turning and sifting.*

For those mixing by hand without a concrete pad, a simple mixing bin can be built with a 4-foot by 8-foot piece of plywood for the bottom, and 2-inch by 6-inch studs as the walls. The seam between the studs and the plywood can

<sup>29</sup> David Buckel, "Urban Community Composting: How to Walk-Turn a Windrow" (2014). Available at <https://www.youtube.com/watch?v=BymDL3hMTXs>.



### SPOTLIGHT - Benny's Approach for a Thorough Mix

Whether you are mixing on a paved surface or in a mixing bin, a systematic approach yields more uniform results and minimizes effort and spillage. Below is an approach for mixing as taught by Benny Erez of ECO City Farms. It can be used as you build a new pile or as you remix an existing pile:

1. Measure your feedstocks in the proportions based on your composting recipe. Add your browns first, starting with the lightest one (so it doesn't blow away). These browns will help absorb any excess liquid from your green materials.
2. Start from one end of your unmixed pile of feedstocks, flipping a shovel-full of material just a foot in front of you. Continue doing so down the length of one side of your pile.
3. If needed, someone else can gently and slowly water the material as it's being mixed, making sure not to add so much that puddles form.
4. Do this for the entire length of the pile before stepping forward to start a new row.
5. Continue like this back and forth until you are a little more than halfway across the width of the pile.
6. Next, walk to the other side of the pile and repeat this process heading in the opposite direction.

Moving the small shovel-loads a small distance minimizes the level of effort and following this pattern ensures a uniformly well-mixed pile. This approach can also be applied to smaller, more manageable batches that are then used to build a larger pile.

Source: Benny Erez, Senior Technical Advisor and Compost Guru, ECO City Farms, Bladensburg and Edmonston, Maryland, [www.ecoffshoots.org/programs/compost](http://www.ecoffshoots.org/programs/compost).



▲ Lead instructor, Benny Erez of ECO City Farms, teaches participants of the 2016 Neighborhood Soil Rebuilder Master Composter course at Real Food Farm in Baltimore how to use a mixing bin to build a new composting pile. *Source: Institute for Local Self-Reliance.*



▲ Members of the East Capitol Urban Farm Compost Project use a mixing bin to build a new composting pile. Because gravel is hard to clean, a tarp is spread out beneath the mixing bin. *Source: Institute for Local Self-Reliance.*

## PART 2 The Science and Art of Composting

be sealed with caulk before the studs are placed on the plywood and screwed in to place to make it leak proof.

Larger operations or those with available financial resources may choose to purchase a mixing machine. JayLor, for example, manufactures mixers as small as 50 cubic feet for agricultural purposes (like mixing animal feed) that lend themselves to composting.<sup>30</sup>

### Moisture Content

The ideal moisture range for our composting mix is between 50 and 60 percent for static piles, and 60 to 65 percent for aerated piles. How do you determine what your moisture content is? If you take a handful of your composting mix, it should feel like a wrung-out sponge. This “hand-squeeze test” is a very quick, easy, and low-tech method for estimating the approximate moisture content in the field.

#### MOISTURE LEVEL ESTIMATIONS

Take a sample of material from at least 6 inches inside the pile and squeeze.

TABLE 3. MOISTURE LEVEL OBSERVATIONS

Observations	Interpretation
Material is crumbly and does not stick together, and your hand is dry	Pile moisture is < 40% = TOO DRY
No more than a few water drops appear between your fingers or knuckles, the material sticks together, and your hand is moist	Pile moisture is between 50% - 60% = IDEAL
Water drips down your arm (especially down to your armpit!), material sticks together and drips, and your hand is wet and dripping	Pile moisture > 65% = TOO MOIST

Source: Adapted from Robert Rynk, “Monitoring Moisture In Composting Systems,” *BioCycle Magazine*, (2008): 27.

Repeat this with samples from a few different spots in the pile to get a sense of the moisture level of the entire pile.

A more accurate moisture content measurement can be determined by weighing a material sample, drying it in an oven for a number of hours, then weighing the sample again, and observing the difference in weight. The Ohio State University has a handy field manual that outlines the



▲ A participant of the Neighborhood Soil Rebuilders Master Composter program puts the hand-squeeze moisture test to use. Source: Institute for Local Self-Reliance.

### THE “HAND SQUEEZE” MOISTURE TEST



Take handfuls from different places in your compost pile and give them a squeeze!  
At the ideal moisture level, a few drops of water should appear between your knuckles and it should feel like a wrung-out sponge.

▲ Source: Institute for Local Self-Reliance.

steps for this process: [https://ocamm.osu.edu/sites/ocamm/files/imce/Compost/Compost-Calculations/Lab\\_workbook.pdf](https://ocamm.osu.edu/sites/ocamm/files/imce/Compost/Compost-Calculations/Lab_workbook.pdf).

Other considerations for managing moisture in your composting mix:

- Fresh ingredients such as leaves and straw are hydrophobic, meaning they repel and shed water, because their cell walls are still intact. For this reason, your composting pile may need to be watered a few days after it is built, as the composting process starts and the cell walls begin to break down. Consider pre-soaking browns for a few hours before using them or storing them in such a way to expose them to precipitation naturally. Food scraps are high in

30 Learn more about compost mixers at <http://jaylor.com/english/mixers/mini.htm>.

## PART 2 The Science and Art of Composting

moisture and as they degrade, the moisture releases. Dry browns can help absorb that moisture.

- Water often needs to be added as the pile is being built to fully incorporate it throughout the mix. A common mistake is to water the pile after it is built. The latter rarely works as the pile simply sheds the water and it is not absorbed.
- Adding moisture might not be necessary if the recipe is good and the pile is mixed well.
- If you lack a water source, pay extra attention to your recipe and sourcing materials with adequate moisture.

### Bulk Density

Bulk density, discussed briefly in the previous section, is an estimation of porosity. It is measured as the weight of a certain volume of a material. For example, the average bulk density of wet food scraps is 1,000 pounds per cubic yard. The ideal bulk density of a material mix for composting is lighter. When building your composting pile, pay attention to particle size and the density of your overall composting recipe or mix. If it is too heavy and dense, air pockets will be insufficient to allow airflow through the pile.

Wood chips and cut-up plant stalks, branches, or straw<sup>31</sup> help increase porosity in the pile and achieve the right bulk density. Certain brown materials serve as bulking agents that decrease density and increase air space in the

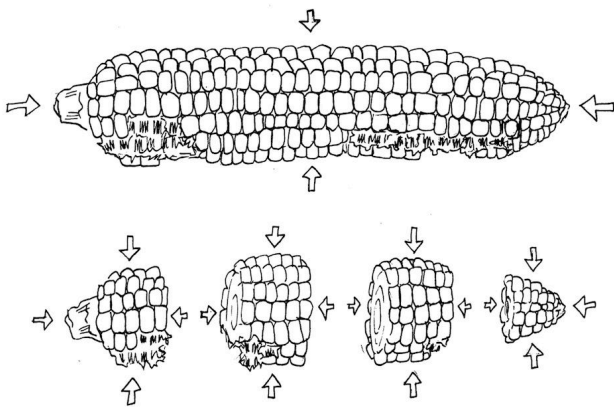

▲ Chopping up larger, tougher food scraps into pieces, increases the surface area available to composting microorganisms. Source: *Institute for Local Self-Reliance*

### Chop, Chop, Chop! Particle Size Rule-of-Thumb

Chopping or shredding big pieces of plant material or whole fruit and veggies before adding to composting pile will speed up the composting process. The *NRAES On-Farm Composting Handbook* recommends an ideal particle size of 1/8 inch to 2 inches for composting. Though it may not be feasible to chop all ingredients to this size, prioritize chopping items like corn cobs, citrus, broccoli stalks, and pineapple tops, which will take longer to break down.

Source: Robert Rynk, *On-Farm Composting Handbook*, Northeast Regional Agricultural Engineering Service (NRAES) Cooperative Extension, (1992): 9.

pile. As with all composting ingredients, bulking agents should be mixed evenly throughout a pile. In addition to the mix of materials, moisture content significantly affects the bulk density. Low bulk density could mean the mix has too much carbon or bulking agent, or is too dry. High bulk density could mean the mix has too much nitrogen-rich material, has too little bulking agent, or is too wet. Bringing the moisture content to the ideal composting range prior to calculating bulk density yields the best results. Remember to use the hand-squeeze test!

The starting optimal range for bulk density is between 800 and 1,000 pounds per cubic yard.<sup>32</sup> Fortunately, you don't need to weigh your whole pile to calculate its bulk density! Instead, it can be estimated with a sample. Washington State University has a helpful step-by-step guide for how to calculate bulk density with a 5-gallon bucket and a scale at: <https://puyallup.wsu.edu/soils/bulkdensity/>.

### Pile Size

The minimum pile size necessary to support the thermophilic microbes that drive the composting process is 27 cubic feet or 1 cubic yard. This is a pile 3 feet high, wide, and deep, or about the size of a washing machine. Larger compost piles are better able to self-insulate and can more readily reach and hold target temperatures than smaller piles. But, piles that are built too large can foster

<sup>31</sup> Straw and hay are not the same thing. Straw is only the stalk of a grain, whereas hay includes the seed head of the plant. Hay is used for animal feed as the seeds provide nutrition. Even so, if you are buying straw, chances are there will be some seed heads in your bale. You may consider leaving your straw bales out to weather for a few months to allow any potential seeds to sprout.

<sup>32</sup> U.S. Composting Council, *Compost Operations Training Course* (2015).

## PART 2 The Science and Art of Composting

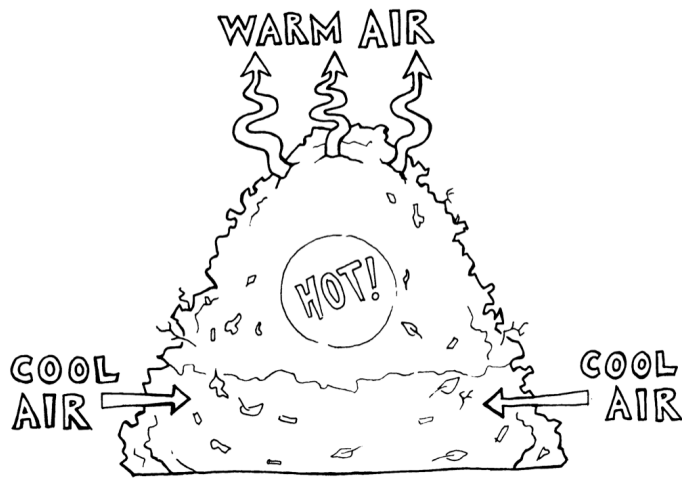

▲ In a properly built aerobic compost pile, air circulates much like in a house with a hot fireplace and a chimney. As the center of the pile heats up, hot air rises from the middle, which pulls cool air into the pile. Source: *Institute for Local Self-Reliance*

pockets of anaerobic conditions due to the weight of the pile compacting the materials on the bottom. The larger your pile, the more important it is to have a good initial mix with the appropriate density and porosity.

Your pile will reduce in volume over time from settling of materials and loss of mass due to decomposition. Smaller compost piles have a greater surface area-to-volume ratio and lose more heat to conduction and radiation than larger piles.<sup>33</sup> When your compost pile falls below 27 cubic feet, the composting process will slow significantly or stop altogether, making it challenging to achieve Process to Further Reduce Pathogens (PFRP) temperatures, or temperatures above 131°F (PFRP is discussed in more detail in the next section). But, never fear! Once your pile is big enough, the composting process should resume – assuming it has everything else it needs.

Here are the maximum pile heights for new piles using different composting system types according to the *NRAES On-Farm Composting Handbook*<sup>34</sup>:

- Windrows: 3 feet (for denser mixes) to 12 feet (for less dense mixes)
- Passively Aerated Static Piles: 3 to 4 feet
- Aerated Static Piles: 5 to 8 feet

The maximum pile width is 20 feet, and should only be used for piles being mechanically turned by skid-steer loader, front-end loader, or windrow turners. Obviously, piles being turned by hand will need to be much smaller to be manageable.

### Pile Shape

The optimal shape for a compost pile is that of a dome, so that it peaks in the middle. The middle of the pile is where the most microbial activity will take place and thus where the most heat will build up. If a pile is built in the shape of a cube, the corners or shoulders will never heat up, leading to "cold shoulders" and inconsistent composting.

As long as sufficient porosity exists, hot air will rise from the middle up via convection. Hot air and vaporized water exit the top of the pile, drawing cool, fresh ambient air into the bottom of the pile. This is referred to as the **chimney effect**. Because the sides of the pile are exposed to the ambient air, they will be cooler than the middle. Turning speeds up the decomposition process because it remixes materials, bringing materials from the outside of the pile into the middle.

Table 4 summarizes the target parameters for creating ideal thermophilic conditions in a new composting pile.

TABLE 4. IDEAL INITIAL PARAMETERS FOR THERMOPHILIC COMPOSTING

Characteristic	Ideal Range
Moisture (%)	50 - 60
C:N	25:1 - 40:1
Oxygen (%)	> 10
Temperature (°F)	120 - 155
Particle Size (inches)	1/8 - 2
Bulk Density (pounds/cubic yard)	800 - 1000
Pile Size (cubic yard)	> 1

Source: Adapted from the USCC Compost Operations Training Program (2015).

33 Nancy Trautman, "Compost Physics," Cornell Composting Science and Engineering. <http://compost.css.cornell.edu/physics.html> (accessed November 2018).

34 Robert Rynk, *On-Farm Composting Handbook*, Northeast Regional Agricultural Engineering Service (NRAES) Cooperative Extension, (1992): 25, 29-30.

# COMMON STEPS IN THE COMPOSTING PROCESS

1

Food Scrap Drop-off  
Mix Scraps with carbon!



COLLECT & STORE  
COMPOSTING FEEDSTOCKS

2

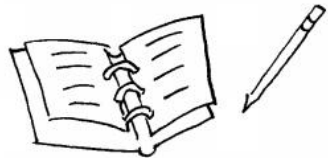

RECORD VOLUME OR  
WEIGHT OF INCOMING  
MATERIALS

3

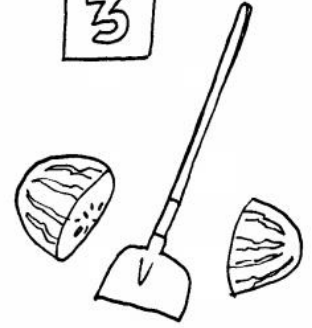

CHOP LARGE  
FEEDSTOCKS  
AS NEEDED

4

MIX FEEDSTOCKS &  
BUILD YOUR COMPOST  
PILE

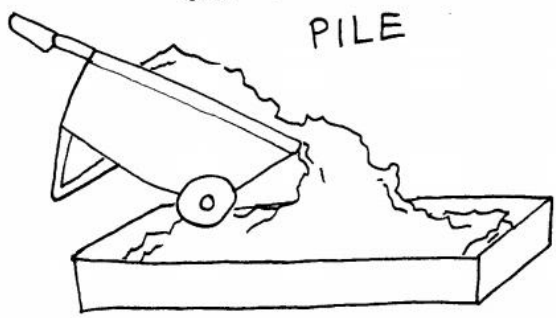

5



MONITOR & RECORD TEMPERATURE  
MOISTURE LEVEL & ODOR

6

MIX &  
WATER  
REGULARLY



7

TROUBLESHOOT  
AS NEEDED

8

CURE

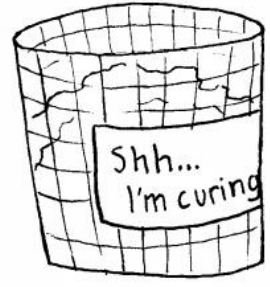

9

SIFT

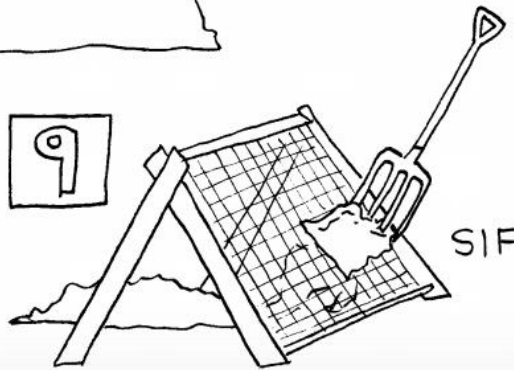

10

USE OR  
STORE  
FINISHED  
COMPOST



▲ 10 common steps for community-based composting. Source: Institute for Local Self-Reliance





## Part 3: Managing the Composting Process and Your Site

Composting is a biological process with decomposer organisms doing most of the work. By optimizing the process, you can accelerate the rate of composting and create a high quality product. The most rapid composting happens when you:

- Start with a balanced, thoroughly mixed recipe (discussed in Part 2),
- Regularly turn or aerate the pile, and
- Monitor and adjust the moisture content as needed.

Part 3 provides guidance on managing the entire composting process and introduces parameters that are important to monitor and track – particularly for projects composting food scraps or animal manures, or producing compost for growing food for human consumption. Part 3 ends with an overview of finishing the composting process and some ideas for putting your well-earned “black gold” to use.

### Turning or Remixing

The temperature of your pile should reach the thermophilic range (105 - 150°F) within a few days of being built. Compost should remain in this range

▲ The NYC Compost Project hosted by Earth Matter NY is located on Governors Island and composts food scraps from the broader NYC community. Source: *Earth Matter*.

## PART 3 Managing the Composting Process and Your Site

for a few weeks. This is considered the active composting stage. Ideally, you would remix, or turn, the pile two to three times a week for the first few weeks. As the process continues, turning can be reduced to a weekly schedule. This is ideal even at small-scale composting sites. Assuming proper C:N ratio and moisture level, this maintains optimal living and working conditions for the composting microbes. If your community has the resources available to maintain this level of effort, it is worth doing. The composting process will proceed more quickly and produce a higher quality product that is more evenly and completely composted.

However, at sites where everything is being done by hand, this schedule may not be physically possible. Weather will also impact turning schedules. For example, in the summer, hot ambient temperatures must be considered for the comfort and safety of staff and volunteers. Rescheduling work days for early in the morning or later in the evening to avoid the heat of the day is one solution. In the winter, if temperatures fall below freezing for extended periods of time, turning should be avoided and aeration should be limited to help keep heat in the pile.<sup>35</sup> In these temperatures, smaller and less active piles may freeze altogether. While insulating your piles may help with this – using straw bales or semi-permeable compost covers, for example – cold temperatures may impact the rate at which materials flow through your site. Take this into account when considering your site's capacity during winter months.

At the least, turn active compost piles when the temperature nears 160°F to avoid killing off your microbes. These high temperatures are more likely to happen where large amounts of food scraps or animal wastes are being composted. Premature low temperatures and odors are also indicators that a pile should be turned. Less frequent turning makes the quality of your initial mix even more important as it affects how long a pile can stay active before it needs to be turned. There will likely be more unprocessed larger pieces of brown materials that need to be sifted out at the end, but these overs can be reintroduced into the process as browns for the next batch. Less frequent turnings should be balanced with regular monitoring.

---

*Less frequent turning makes the quality of your initial mix even more important as it affects how long a pile can stay active before it needs to be turned.*

When you turn a pile, your goal should be to move what was in the outside of the pile to the middle. Rebuilding the pile by moving the materials into a new spot beside where the original pile stood is perhaps the most thorough way to do this. If using a bin system, pulling the material out into a mixing bin or onto a tarp or concrete pad and then rebuilding your pile when it's nice and mixed is a good way to do this. Practically speaking, you can't really track each particle, so a good mix is important.

Adjusting recipes is inevitable as feedstocks change or as problems arise and troubleshooting is needed. A good time to check in with the composting process is during remixing or turning. Alter your recipe according to your observations of moisture content, material bulk density, odor, and temperature. Let your senses guide you. Smell bad? Add browns. Dry and brittle? Add water. Even a seemingly perfect recipe can be affected by other factors such as overly wet weather conditions or a feedstock that isn't behaving as expected. This is why monitoring and keeping records are so important.



▲ A mixing bin being used to turn compost piles at the East Capitol Urban Farm Composting Project in Washington, DC. Source: *Institute for Local Self-Reliance*.

<sup>35</sup> James McSweeney, *Community-Scale Composting Systems: A Comprehensive Practical Guide for Closing the Food System Loop and Solving Our Waste Crisis* (Chelsea Green Publishing, 2019).

## PART 3 Managing the Composting Process and Your Site

*Alter your recipe according to your observations of moisture content, material bulk density, odor, and temperature.*

### Monitoring and Keeping Records

Regularly mixing or turning a pile and tracking temperatures, odors, moisture, and pest pressure are good practices for any composter. Make sensory observations and keep records. These practices should be required for sites processing animal manures and food scraps from more than one household, or producing compost for sale or food production. Record moisture content and temperatures daily if possible until you acquire a feel for the process. A pattern should emerge after several batches of materials have been composted.

Use compost thermometers to gauge and record temperatures. Use your senses – your nose, your eyes, and the hand-squeeze test – to observe odor levels, moisture content, and pest activity throughout the composting process. Allow these measurements and observations to guide the process. Trends observed by tracking these four factors will inform adjustments that you may need or want to make. A sample data tracking sheet to keep track of this information is provided in *Appendix D: Sample Composting Monitoring Data Sheet*.

*Regularly mixing or turning a pile and tracking temperatures, odors, moisture, and pest pressure are good practices for any composter. Make sensory observations and keep records.*

### Temperature

The heat produced during composting is directly related to the level of microbial activity.<sup>36</sup> Thus, temperature is a useful measurement for assessing the composting process. The most rapid decomposition takes place between 122 and 140°F,<sup>37</sup> but certain seeds are only killed at slightly higher temperatures. If the pile is cold when it should be in

### What Does Turning Do?

- Charges the materials with fresh air
- Releases trapped heat, moisture, and gases (for better or worse)
- Distributes moisture, nutrients, organisms
- Breaks up and redistributes air channels
- “Fluffs”
- Shreds particles
- Breaks apart clumps of materials
- Generally invigorates and provides a burst of activity

Source: U.S. Composting Council, Compost Facility Operator Training (2015).

BK ROT COMPOST LOG		PILE TEMPERATURES		
DAY/DATE	WORKER	BIN #	TEMP	ACTIONS/OBSERVATIONS
5/22/16	Domingo	Window	100	used to seal new pile
11	11	4	81	Sifted
11	11	3	94	moved over
Shelby	Daniel / Domingo / Claudia	2	140	moved over
11	11	1	156	started new
11	11	1	135	Turned/Watered/Added
11	11	2	148	11
11	11	3	144	11
11	11	4	118	11
11	11	Window	150	Watered

BK ROT in Brooklyn uses a simple data log to track temperatures and other observations and actions. Sources: Institute for Local Self-Reliance, BK ROT.



36 Nancy Trautman, “Compost Physics,” Cornell Composting Science and Engineering. <http://compost.css.cornell.edu/physics.html> (accessed November 2018).

37 James McSweeney, *Community-Scale Composting Systems: A Comprehensive Practical Guide for Closing the Food System Loop and Solving Our Waste Crisis* (Chelsea Green Publishing, 2019).

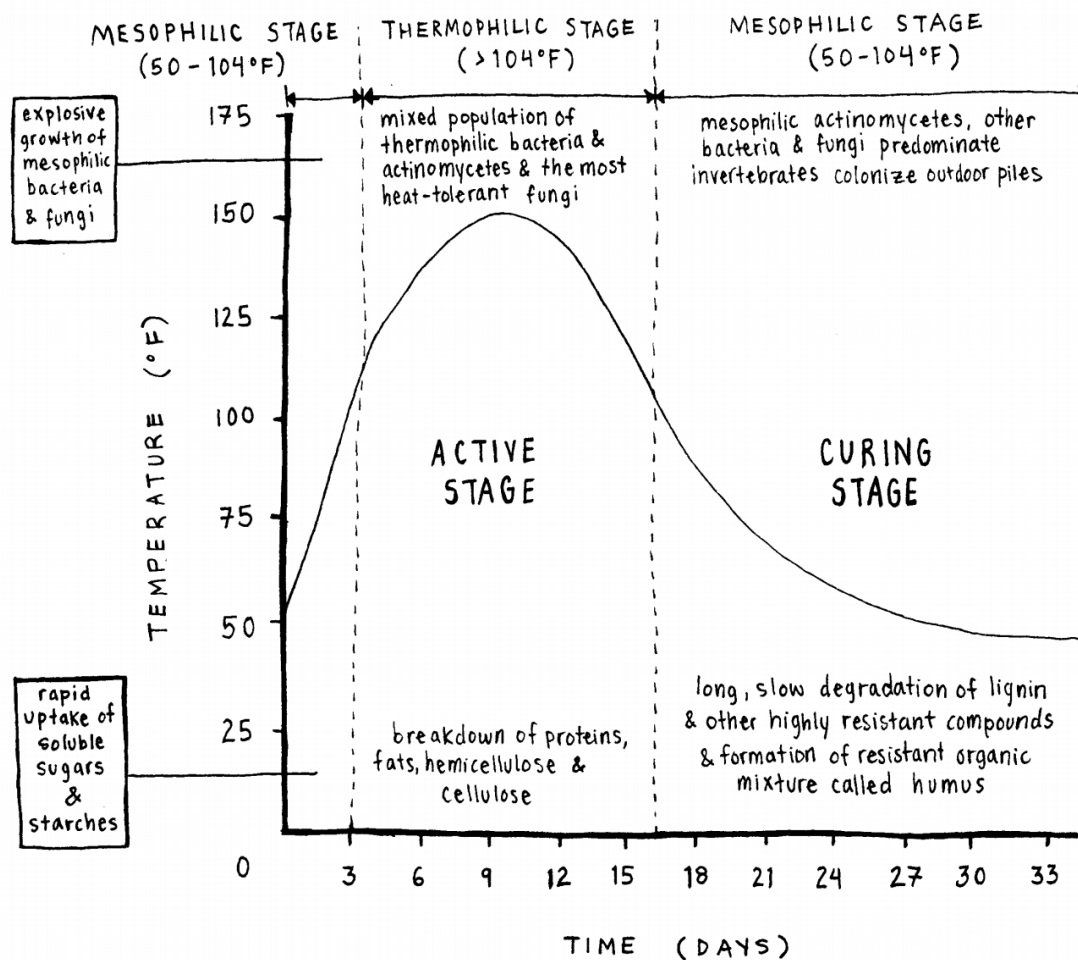

▲ The Three Phases of Thermophilic Composting. Illustration adapted with permission from Nancy Trautman and Marianne Krasny's *Composting in the Classroom: Scientific Inquiry for High School Students* (1997).

the active phase, this means the microbes are not active and are likely not happy. Temperatures that are too high are also an indication that conditions need to be adjusted. In either case, you will want to troubleshoot to improve the pile conditions (see *Appendix B: Troubleshooting FAQ*). After a few weeks in the active hot phase, when the pile no longer heats after mixing, you will know it's time to allow it to cure. There are three distinct temperature phases.

#### MESOPHILIC (50-104°F):

Once the pile is built, things immediately begin to heat up. During this stage, mesophilic bacteria will begin to eat substrates with high-energy yield like sugars, starches, and fats. As a result, the pile will start to warm up in just a few hours in ideal conditions. Under the right conditions, the mesophilic stage only lasts a few days before moving into the thermophilic stage.

#### THERMOPHILIC (105-160°F):

Once temperatures increase above 104°F, thermophilic bacteria continue to eat simple compounds with high-energy yield. With sufficient food, water and air, these microbes can bring the temperature up to 150°F or higher. Fortunately, most human pathogens and many weed seeds cannot handle such high temperatures. Most weed seeds are killed at 145°F, but tomato seeds may persist until around 153°F. Much above 155°F, composting microbes begin to die off and decomposition slows. The thermophilic stage can last a few days to a few months depending on the size of the pile and type of inputs. During this time, most of the organic matter is reduced to humus and materials begin to resemble finished compost.

#### CURING (50-104°F):

Curing is marked by a sustained drop in temperature back into the mesophilic range. As the pile cools down, fungi



### SPOTLIGHT - The Process to Further Reduce Pathogens (PFRP)

According to the U.S. Composting Council, because food residuals have high moisture content, and due to the system in which human foods are produced, they are at a high risk of containing human pathogens, fungi, and bacteria.<sup>a</sup> For this reason, it is of utmost importance that certain composting sites monitor temperatures and follow the Process to Further Reduce Pathogens (PFRP) time-temperature protocols. This includes sites processing animal manures and food scraps from more than one household, or producing compost for sale or food production.

Large-scale commercial-industrial food scrap composting sites are required to meet PFRP. While most small-scale composting systems are not, meeting PFRP will help assure that you are creating a final product that is safe to use for food production. Basically, PFRP means compost processing time and temperatures should be sufficient to kill most weed seeds, and reduce pathogens (such as *E. coli* or salmonella) and prevent vector attraction (unwanted critters).

To meet PFRP, material composted in enclosed systems must be maintained at a minimum average temperature of 131°F (55°C) or higher for three continuous days. Passively aerated and windrow style piles need to keep material at a minimum average temperature of 131°F (55°C) or higher for at least 15 days (they don't always need to be consecutive days, but check with your state regulators to be sure). During this period, there must be a minimum of five turnings with a minimum of three days between turnings.<sup>b</sup>

To render persistent weed and otherwise unwanted seeds inactive, such as tomato or pumpkin seeds, we further recommend 153°F as the target temperature to reach for at least three continuous days. It is important to note that everything in our pile must hit these temperatures – that means that these temperatures must be reached after new material has stopped being added. Although there will be instances where a pile may need to be reinvigorated with a boost of fresh nitrogen, remember that adding new material to your pile (particularly food scraps or manures) means that you must start the PFRP process anew.



▲ A composting pile in the active phase of decomposition. Source: Institute for Local Self-Reliance.

<sup>a</sup> Eva M. Christensen, *Best Management Practices (BMPs) for Incorporating Food Residuals Into Existing Yard Waste Composting Operations*, U.S. Composting Council (2009).

<sup>b</sup> Personal communication, Cary Oshins, US Composting Council, November 21, 2018. According to Cary, "you don't have to turn 5 times within 15 days; you have to turn 5 times with pile temps at or over 131 for at least 15 of those days." Also see the U.S. Composting Council Model Compost Rule Template, which provides a template for state regulators (available online at <https://compostingcouncil.org/state-compost-regulations-map/>). The template recommends that pathogen and vector attraction reduction compliance be achieved as follows:

i. Windrow composting: the compost material must be maintained at a minimum average temperature of 55°C or higher for 15 days or longer. During the period when the compost is maintained at 55°C or higher, there shall be a minimum of five turnings of the windrow with a minimum of 3 days between turnings. The 15 or more days at or above 55°C do not have to be continuous;

ii. Aerated static pile or in-vessel composting process: Material maintained at a minimum average temperature of 55°C or higher for three continuous days.

## PART 3 Managing the Composting Process and Your Site

and actinobacteria become more active, metabolizing the more complex cellulose and lignin-rich materials. While composting has slowed during this stage, it is still occurring, and the humus content of the pile is increasing. After time to cure and mature (at least four weeks, but sometimes multiple months), the compost has reduced plant toxins and will have a lower amount of oxygen and nitrogen.

### Aeration and Odors

The microorganisms associated with composting require oxygen, therefore composting is an aerobic process. As oxygen (O<sub>2</sub>) and carbon dioxide (CO<sub>2</sub>) meters are not commonly used at the community-scale, proper porosity and consistent aeration or turning are critical. Favorable conditions within the pile will increase microbial activity and reproduction. The proliferation of microbes will increase the temperature and the consumption of more oxygen. As materials decompose, the structure of your composting pile will collapse, reducing its porosity.

Imagine that by creating a well-balanced composting pile, you are essentially setting out a feast for your composting organisms. In a joyous frenzy, they will increase in number and quickly begin consuming the “home” you’ve built them (your composting pile). As they consume the materials that provided the good structure in your initial composting mix, the walls of their “home” will begin to collapse. This reduces the volume of your pile and air space. At the same time, the larger number of organisms are respiring – consuming oxygen and emitting carbon dioxide – at an increasing rate.

This all leads to the reduction in the level of oxygen and an increase in carbon dioxide in your pile. Material must be turned or aerated regularly to maintain an adequate oxygen level (greater than 5 percent is critical but 10 percent is the optimal level).<sup>38</sup> Of particular importance are the middle and bottom of the composting pile. The previous Turning section provides a suggested mixing schedule. Use pile temperatures and your nose as your gauge. Tracking temperature will give you an indication if oxygen is adequate or not.

If the temperature is above 150°F, this indicates high microbial activity, which means they are quickly consuming available oxygen. This leads to conditions where oxygen is



▲ Using a shower setting and adding water while mixing will ensure maximum absorption. Source: *Institute for Local Self-Reliance*.

low and carbon dioxide is high. Piles lacking sufficient porosity, or space for air to infiltrate, will not be able to supply sufficient oxygen to meet the oxygen needs of these microbes. If a bad smell like ammonia or hydrogen sulfide (rotten eggs) is present, this indicates parts of the pile have gone anaerobic. If the process is aerobic throughout the pile, nuisance odors can generally be avoided. Remember the rule, “your nose knows.”

### Moisture

If a pile is regularly aerated or turned to maintain air pockets, piled high and wide enough to keep heat in the middle of the pile, and has adequate moisture, it can thrive. Water should be added as needed while a pile is being built (if your feedstocks are dry) and during turnings or mixings throughout the active phase when temperatures are greater than 104°F. We have observed that as much as 20 gallons of water may be needed when building a 64-cubic-foot pile. More may be needed as piles heat up and hit temperatures of 131°F or higher. Once decomposition slows and returns to the mesophilic phase (less than 105°F), microbes will need less water and you will not need to add as much.

### Pests

When you are adding material to your composting system or checking on the composting process, this is also a good time to check for critter activity. Where pressure from rodents is great (such as in urban areas), keep an eye out for signs such as burrow holes in the ground or signs of chewing on your system. If you do see activity, cut off their

38 U.S. Composting Council, *Compost Operations Training Course* (2015).

## PART 3 Managing the Composting Process and Your Site

access to food and hiding places immediately. Here are some additional steps to take:

- Fix any holes in bins immediately. Keep in mind that a ½-inch gap is big enough for a rat to squeeze through, while a ¼ inch is big enough for mice.
- Try moving your composting system around every few weeks to discourage nesting.
- Maintain your 3-foot buffer! Clean up any nearby piles of materials and other clutter. Secure any browns or finished compost in sealed bins or move them around periodically to keep animals from nesting.
- Trim back nearby shrubs to provide an 8- to 10-inch clearance from the ground. Trim back branches of nearby trees to at least 6 feet above your composting system and other nearby structures.
- Mow down any nearby tall grasses so that the ground is visible.
- Consider power-washing any nearby paved surfaces.

Again, reach out to your state's wildlife agency, or look at resources they have available online, to determine what wildlife species may be active in your area. They may even have specific recommendations for preventing these species from gaining access to compost piles.

For more information on this topic, view ILSR's webinar, *Successful Rat-Prevention for Community Composting* and other relevant resources at <https://ilsr.org/successful-rat-prevention-for-community-composting-webinar/>.

### Managing Problems

Be ready to cut off or divert food scrap deliveries if problems arise. These may include complaints from neighbors or regulators, rodent infestations, shortage of browns, or existence of other unmanageable nuisances. Composting should cease until the problem can be solved. This means you should not accept new material or build new piles. If animals have burrowed in any of your composting piles, including piles that are curing or finished, this material is now contaminated and should likely be disposed of. This is particularly true for rodent infestations. If you suspect only minimal animal activity, the material in question can be mixed in with a fresh pile so that the material can reach PFRP temperatures or be

solarized. **Solarization** involves using radiant heat from the sun to kill pests, pathogens, and unwanted seeds. Most simply, this can be achieved by placing the material to be treated in a plastic bag and leaving it in a sunny spot for four to six weeks. For more information, see *Appendix B: Troubleshooting FAQ*.

### Avoiding Unwanted Critters

- Avoid composting meat, dairy, and cooked food
- Incorporate all bits of food well into pile
- Windrows should be sealed with a uniform depth of at least 6 inches of finished compost
- Place piles with open space all around (makes rodents nervous about predators)
- Turn piles well so rodents see no opportunity for a habitat
- Bin systems need a barrier at the base to prevent habitat formation where it's nice and warm (like cement, a dug-out pit with sand, or something else inhospitable)

Source: David Buckel, Red Hook Community Farm, Brooklyn, NY.

## Finishing the Composting Process

After your compost pile has passed through the active composting phase, there are a few final steps you need to take before you have a finished product ready to be added to soil. This section outlines these steps.

### Curing

Curing allows the aerobic decomposition or composting process to gradually come to a close to produce a more chemically stable, plant-friendly finished product. During this stage, pH is neutralized, the humus concentration increases, and the ability of the compost to store nutrients also increases via an increase in cation exchange capacity.<sup>39</sup> **Cation exchange capacity** refers to the capacity of the soil to attract and hold on to positively charged mineral ions, or cations, or what we think of as nutrients. Weeks to months after a pile has been built, the temperature will

39 Robert Rynk, *On-Farm Composting Handbook*, Northeast Regional Agricultural Engineering Service (NRAES) Cooperative Extension, (1992): 13.

## PART 3 Managing the Composting Process and Your Site



▲ A compost screener and curing enclosure, both made using hardware cloth, at the Howard University Community Compost Cooperative. Source: Loop Closing.

return to the mesophilic range (lower than 105°F). Compost is ready for curing when it no longer has recognizable food scraps and the pile no longer heats up beyond 104°F after turning.

*Curing allows the aerobic decomposition or composting process to gradually come to a close to produce a more chemically stable, plant-friendly finished product.*

At this point, a diverse array of microbes repopulate the compost, and we want it to stay that way. They will need some water, though not as much as before, and plenty of air. Anaerobic conditions at this stage can create odors and phytotoxic chemicals. Adequate aeration can be achieved by limiting the size and moisture content of the curing pile. Piles of curing compost should be limited to 6 feet tall and 15 to 20 feet wide. Water may no longer need to be added, as the moisture level only needs to stay around 40 percent (remember the hand-squeeze test!). As long as aeration and moisture levels are managed and odors are not present, curing piles do not need to be turned.<sup>40</sup>

Adding unfinished compost, or incompletely decomposed material, to a garden bed is not recommended. In unfinished compost, bacteria compete with plants for nitrogen in the soil, continue to consume oxygen – reducing the availability of oxygen to plant roots – and can also contain high levels of organic acids. These factors can

stunt plant growth. A minimum of four weeks is needed for curing but two to four months is recommended. When the compost pile heads towards **ambient temperature**, or the temperature of the surrounding environment, the compost should be ready to be sifted.

### Sifting or Screening Finished Compost

Sifting or screening the finished compost is a good idea in order to remove big pieces of wood chips and any other materials that may not have decomposed fully. If mixed into the soil, big pieces of carbon may bind nitrogen in the soil as microbes will want to decompose this material. There are many screener options, including DIY wood-framed hardware cloth. It can be a simple frame held horizontally over a wheelbarrow, bin, container, or tarp for collecting the finished materials. The frame can be propped up on an angle or with two legs, or horizontally with four legs (like a table). Trommel screens or rotating cylinders of hardware cloth can also be built, but require a bit more skill. There are certainly many more expensive off-the-shelf options as well.

Depending on how fine you want your final product, ¼-inch or ½-inch hardware cloth will work. Moving the screen side to side helps move the fine particles through (better than bouncing it up and down). The screened out material is referred to as the **overs** and can be recycled as browns and bulking material into a new pile. The overs can actually help inoculate the new pile with the beneficial decomposers.



▲ Youth employees of the Baltimore Compost Collective sift compost. Source: Marvin Hayes, Baltimore Compost Collective.

40 Robert Rynk, *On-Farm Composting Handbook*, Northeast Regional Agricultural Engineering Service (NRAES) Cooperative Extension, (1992): 13, 51-52.



*If mixed into the soil, big pieces of carbon may bind nitrogen in the soil as microbes will want to decompose this material.*

### When Is Compost Ready?

Completely finished compost is a dark brown, earthy-smelling material similar to rich organic soil that is **homogenous** and is within 10°F of ambient temperature.<sup>41</sup> Original material feedstocks should not be recognizable with the exception of a few wood chips or twigs, which can be screened out. Regular compost quality testing is recommended for any site that is producing compost for sale, creating compost for food production (not including use in a personal garden), or accepting materials that have the potential for pathogens (such as manures, meat, large amounts of food scraps from off-site).

In order for compost to be ready for use, it needs to be mature. For assessing the maturity of a given batch of compost, the U.S. Composting Council (USCC) recommends conducting at least one test each for stability and fitness for use. **Stability** refers to how much energy-rich feedstocks remain for composting microbes to consume and whether or not it is still being actively decomposed. **Fitness for use** refers to the level of free ammonia and volatile organic acids present in the compost. These substances are released during the decomposition process and make immature compost **phytotoxic**, or toxic to plants.<sup>42</sup>

Some tests can be done for little or no money. Here are a few simple ways to test for compost maturity.

- The “ziplock test,” a quick test for gauging compost stability: place a handful of moist compost in a plastic ziplock baggie, close and store in a dark place for three days. Smell immediately upon opening. If you smell an ammonia odor, the compost is not finished! Give it more time to cure before testing again. As this test is pretty subjective, use it solely as a first step in your compost testing procedure.

- The seed germination bioassay tests for phytotoxicity: take a plate and add a layer of your compost. Take a packet of new seeds, plant them in the compost, and water gently. Watercress and radish seeds are often used. Keep track of how many seeds you planted so that in a few days, when the plants have sprouted, you can compare your germination rate with the rate printed on the packet or the average germination rate found online. If nothing grows, your compost is not providing a hospitable environment for plants. If you have a good growth rate, you likely have some good compost on your hands! To make this test more robust, test multiple samples of compost from the same batch under the same conditions (light, water, and seeds), or compare with a control, such as commercial germination soil mix.
- One test for both stability and phytotoxicity, the Solvita Compost Maturity Test: this is an off-the-shelf kit that measures carbon dioxide (CO<sub>2</sub>) and ammonia (NH<sub>3</sub>), which are the most common gases released during the composting process. Carbon dioxide is a measure for stability, as it represents how active your composting microbes are and how much they are still respiring. The presence of ammonia tells us there is still unstable nitrogen in your compost, and that it may be phytotoxic. A 6-pack of the Solvita Compost Maturity Tests can be purchased for about \$200 at: <https://solvita.com/product/solvita-compost-maturity-test-kit-6-pk/>

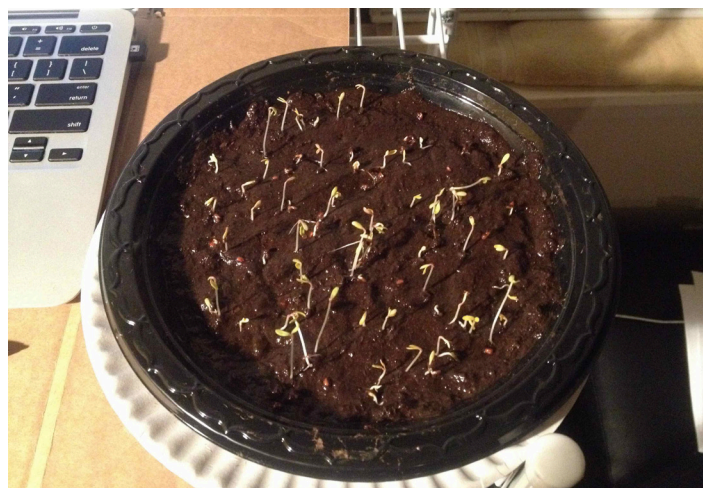

▲ A bioassay test of a compost sample. Source: Loop Closing.

41 Nancy Trautmann and Tom Richard, *Cornell Composting: Composting in Schools Frequently Asked Questions* (1996). <http://compost.css.cornell.edu/faq.html> (accessed November 2018).

42 U.S. Composting Council, *Compost Operations Training Course* (2015).



### SPOTLIGHT - Compost Testing

Below is a simplified testing procedure for measuring pH and electrical conductivity adapted from the Neighborhood Soil Rebuilders Composter Training Program. Benny Erez of ECO City Farms created this procedure.

#### Sample Preparation:

- Use the same sample for pH and electrical conductivity measurements.
- Weigh 30 grams of compost into a small flask (approximately 250-ml).
- Add 150 ml of deionized water to the flask.
- Swirl the flask to mix and submerge entire sample. Let the flask sit for 30 minutes.
- Swirl occasionally.
- For electrical conductivity measurement the sample needs to soak in water for 3 hours.

#### pH Measurement:

- Turn on the pH meter.
- Calibrate the meter following manufacturer instructions.
- When the calibration is complete, rinse the electrode and place it in the sample flask.
- Wait for the meter reading to stabilize and record the pH.
- Rinse the electrode between samples.

#### Electrical Conductivity Measurement:

- After three hours, pour only the liquid from the sample flask into a plastic beaker, through a coffee filter paper to get a clear liquid.
- Turn on the EC meter.
- Calibrate the meter following manufacturer instructions.
- When the calibration is complete, rinse the electrode and place it in the clear liquid sample.
- Wait for the meter reading to stabilize and record the electrical conductivity.
- Rinse the probe between samples and when finished.



▲ Participants of the Neighborhood Soil Rebuilder Composter Training Program learn about compost testing. *Source: Institute for Local Self-Reliance.*

## PART 3 Managing the Composting Process and Your Site

Other recommended field tests for compost are **pH** and **electrical conductivity** (EC) – measured by the ability of soluble salts in compost to carry an electric current. Meters and kits can be purchased for both, with a combined EC and pH meter costing around \$150. Information provided by the manufacturer, such as the product specifications or user manual, will outline how to calibrate your meter and which calibration solutions you will need to purchase. Plastic flasks or beakers (plastic minimizes electromagnetic interference), graduated measuring cylinders, deionized water, stirrers, and a scale will also be useful. Pike Agri-Labs sells field tools for compost testing: <http://pikeagri.com/index.php>.

Certain characteristics are best determined by a laboratory. These include: C:N ratio, nutrient content, organic matter, trace metals, inerts, and pathogens such as fecal coliforms and salmonella. Biological activity can also be observed under a microscope. Rust Belt Riders, a community composting enterprise in Cleveland provides biological analysis of compost samples. Local laboratories, often associated with universities, will offer some soil testing services. However not all labs will be geared towards assessing compost. Think about what analysis you want done, then find a laboratory that will provide that information.

The USCC created the Seal of Testing Assurance (STA) compost certification program to help standardize the testing of compost and determine what composts are suitable for what purposes. The program involves a suite of physical, chemical, and biological tests. While it may not make sense for your small-scale project to become certified under the STA program, there are STA-approved compost testing laboratories around the country that are available for testing individual samples. The full STA suite of testing costs about \$350, but many of these labs offer more basic packages.<sup>43</sup> The USCC recommends a testing frequency based on the volume of compost an operation produces annually. For operations producing up to 6,200 tons of compost each year, they recommend laboratory testing once per quarter (every 3 months).<sup>44</sup> Local rules may also dictate a frequency for compost testing.

Whether you test compost samples in the field or send to a laboratory, make sure they are representative of the entire batch you want tested. According to Woods End Laboratory, if you are taking samples from a well-mixed compost pile, collect 5 to 10 samples, mix them together in a bucket, and take enough from the bucket to fill a 1-gallon ziplock bag. This will result in a representative sample of the compost pile. If you are sampling from a pile that has not been recently mixed, you'll need to cut into your pile (using a front-end loader or shovel) and collect 5 samples from each side of your cut. This should be repeated at 3 to 5 other spots in the pile. These samples should then be mixed in a bucket, and used to fill a 1-gallon ziplock.<sup>45</sup>

Table 5 lists the ideal ranges for the properties of finished compost.

TABLE 5. IDEAL PROPERTIES OF FINISHED COMPOST

Characteristic	Ideal Range
pH	6.0 - 7.5
EC (mmhos/cm)	2.5 - 4.0
Moisture Content (%)	40 - 50
Bulk Density (pounds/cubic yard)	800 - 1000

Compost being used for potted plants should have an EC of < 2.5 mmhos/cm. Mmhos/cm = millimhos per centimeter and is a measure of electrical conductivity.

Source: Adapted from the USCC Compost Operations Training Program (2015); and Robert Rynk, *On-Farm Composting Handbook*, Northeast Regional Agricultural Engineering Service Cooperative Extension, (1992), pg.79.

## Using Finished Compost in the Garden

Compost can be used in a variety of ways. It can be added directly to soil and applied around the roots of plants, known as a side dress or top dress. Potting mix can be made with compost, as well as compost tea. More is not necessarily better, as the health benefits to plants and soil can typically be achieved with 10 to 20 percent compost addition. Low compost application rates are less likely to cause negative effects such as phytotoxicity or high pH and electrical conductivity.<sup>46</sup>

### SOIL INCORPORATION

Compost can be mixed into a garden bed prior to seeding

43 For a list of the laboratories participating in the U.S. Composting Council's Seal of Testing Assurance Program, visit: <https://compostingcouncil.org/labs/>.

44 Learn more about the U.S. Composting Council's Seal of Testing Assurance Program online at: <https://compostingcouncil.org/seal-of-testing-assurance/>

45 Woods End Laboratory, *Principles and Practice: Compost Sampling for Lab Analysis*, <https://woodsend.com/wp-content/uploads/2011/03/sampli1.pdf> (Accessed March 2019).

46 D M Sullivan, and R O Miller. "Compost quality attributes, measurements, and variability." In *Compost Utilization in Horticultural Cropping Systems*, edited by Peter G Stofella and Brian A Kahn, 95-120. Boca Raton, LA: Lewis Publishers, 2001.

## PART 3 Managing the Composting Process and Your Site

or transplanting. Add a 2- to 4-inch layer to the soil surface, and till into the top 6 to 8 inches of the soil.<sup>47</sup> Mixing the compost into the soil helps to protect the rich microbial diversity from being killed off by the sun. This method is a great way to directly benefit the plants and soil, but the compost must be completely mature. Unfinished compost removes nitrogen from the soil, can starve plants, and may contain phytotoxic compounds, which can lead to inhibited germination and stunted growth.

### MULCHING TREES AND SHRUBS

Adding a layer of compost as mulch incorporates nutrients more slowly but is still beneficial. This method may be useful for compost that is still curing. By not incorporating it into soil, you are preventing the removal of plant nutrients. It will slowly decompose and add nutrients. Mulch also insulates the soil, moderates temperature, and limits water evaporation.<sup>48</sup> Pull up sod around desired plants, and use a hand cultivator to loosen the top 2 to 3 inches of soil. Then add a 3-inch thick layer of compost mulch, being careful not to pile material against the trunk of the tree.<sup>49</sup>

### POTTING MIXES

Compost can also be used as a component in potting mixes. It can be added to commercial mixes or used to make potting mix from scratch. Potting mixes generally contain varying parts finished compost, vermiculite, perlite, coconut coir, or peat moss. When using compost for potting mix, use a screened compost that does not contain many large particles. Running the compost through a 1/4-inch screen helps ensure a more homogenous mix.

The following are potting mix recipes from the Cornell Waste Management Institute's *Master Composter Resource Manual*:<sup>50</sup>

#### For seedlings in small containers:

- Sift compost through a 1/2-inch mesh
- Mix:
  - two parts compost,
  - one part coarse sand, and
  - one part loamy soil or coconut coir
- Add a 1/2 cup of agricultural lime (pulverized limestone) per 8 gallons potting mix
- Use liquid fertilizers when true leaves emerge

#### For growing transplants and plants in larger containers:

- Sift compost through a 1-inch mesh or remove larger particles by hand
- Mix:
  - two parts compost;
  - one part ground-up bar, perlite, or pumice;
  - one part coarse sand; and
  - one part loamy soil or coconut coir
- Add a 1/2 cup of lime and a 1/2 cup of 10-10-10 fertilizer per 8 gallons of potting mix
- An alternative organic fertilizer can be made from a 1/2 cup of bloodmeal or cottonseed meal, 1 cup rock phosphate, and a 1/2 cup kelp meal



Information on how to use compost at Earth Matter NY's Compost Learning Center, Governors Island, New York City. Source: Institute for Local Self-Reliance.

47 NYC Compost Project, [NYC Master Composter Course Manual](#) (2015): 5-9.

48 Cornell Waste Management Institute, [Master Composter Resource Manual](#) (1998):19 -20.

49 NYC Compost Project, [NYC Master Composter Course Manual](#) (2015): 5-12.

50 Cornell Waste Management Institute, [Master Composter Resource Manual](#) (1998): 19 -20.

### Health and Safety Considerations

Community composting sites play a special role in engaging the communities that they serve. Be intentional about protecting the wellbeing of staff, participants, and other visitors. Throughout this guide we have outlined tips for good site hygiene and avoiding critters, including: managing putrescible feedstocks appropriately, avoiding clutter and standing water, protecting actively composting piles, maintaining a 3-foot buffer around your composting area, monitoring for animal activity, and more. Enacting these practices will help to create a safer working environment for anyone coming into contact with your site. However, even at composting sites where best management practices are strictly instituted, potential hazards exist. Take time to identify them and create basic operating procedures to manage them.

Clear and open communication with staff and volunteers is important for many reasons. Make sure people feel comfortable to proactively communicate any safety concerns related to the composting site to help avoid potential issues. Perhaps a locked gate or adjusted volunteer hours (to avoid evening times) will help participants feel and be safer. Or perhaps animal activity at the site has reached a critical point, and composting must be halted until the problem is resolved. Trained staff and participants are an asset to any community composting project. Let them know you appreciate them by being prepared to act on their concerns in a meaningful way as soon as possible.

As discussed throughout this guide, microbes are the workforce of the composting process and we are specifically cultivating a hospitable environment for them. These microbes belong at the composting site, not on your hands, clothes, and shoes to be transported elsewhere. Anyone handling composting feedstocks or actively composting piles should wear gloves. Anyone with cuts and abrasions should cover them with waterproof bandages and wear nitrile gloves under regular gardening gloves. Composters and gardeners should always wash their hands with soap and warm water after handling composting materials, finished compost, soil, or tools before eating, using cellphones, or handling fresh produce or anything else that will be consumed by others. Composting tools should be rinsed after use and should not be used for gardening.



Red Hook Community Farm has designated tools for composting that are labeled and stored separately from gardening tools. Source: *Institute for Local Self-Reliance*.

The NYC Compost Project hosted by the Lower East Side Ecology Center recommends the following personal protective equipment:

- Gloves to protect hands from cuts, scrapes, and hygienic contamination
- Overshoes to protect boots when navigating through standing water and contact water
- Steel-toe boots to protect feet from injuries due to rolling or falling objects and equipment
- Coveralls to prevent bioaerosols and dusts that can collect on clothing from being transported off-site (and to protect staff from extreme cold weather)

## PART 3 Managing the Composting Process and Your Site

- Protective goggles or a full face visor to protect eyes and face
- Respiratory masks to protect lungs from sawdust and bioaerosols<sup>51</sup>
- Earplugs to protect ears from loud equipment and tools

**Bioaerosols** are microbes and other living biological particles suspended in air and are present at composting sites. Bioaerosols can cause illness if they are inhaled.<sup>52</sup> Other airborne particles, such as dust, can cause physical irritation. Have respirator masks (N95 mask recommended) available for use in dry, dusty conditions as well as for those who have asthma, other respiratory issues, or cystic fibrosis.

Though most people will not be affected, **Aspergillus fumigatus** is a common fungal species found in soil, decomposing leaves, and compost. Spores to which susceptible individuals – such as those with suppressed immune systems, illnesses, or diseases affecting the lungs – may be sensitive, can become airborne when materials are being moved around. Respirator masks can be helpful, but all participants should be informed of the possibility of this sensitivity and should be encouraged to monitor their wellbeing.

Diseases carried by rodents can be contracted by breathing in dust that is contaminated with rodent urine and droppings; by having direct contact with urine or droppings; or by having direct contact with soil or water that has been directly infected. If your site has active burrowing or fresh urine or droppings are present, any materials on site could potentially be infected.<sup>53</sup> These materials should be disposed of as they may be infected with **Leptospirosis**, a bacterial disease.<sup>54</sup> Active burrows require immediate action to make your site inhospitable to rodents. If the problem cannot be remedied quickly, pest management professionals should be contacted.<sup>55</sup>

Protect those likely to be most sensitive. Involve participants and guardians where appropriate to discover anyone potentially susceptible: those with allergies,

asthma, weakened immune systems or who are prone to infection. Turning the composting pile will release airborne particles and gases that can cause symptoms in some people. Do not stir or otherwise disturb the pile or bin when people susceptible to inhalation of allergens are nearby. Maintaining proper moisture, regularly turning and mixing (avoiding windy days), and watering while mixing will help minimize exposure to healthy individuals that are physically able to manage the compost.

Providing staff with proper training and appropriate protective equipment for any heavy machinery is also important. Having a general safety plan in case of an emergency is advisable and make sure participants and visitors know who to contact when something does happen. Have a first-aid kit available and make sure everyone knows where it is.



▲ Informational signage guides participants on washing buckets used to store food scraps at the NYC Compost Project hosted by Earth Matter NY. Source: Institute for Local Self-Reliance.

51 The Lower East Side Ecology Center recommends operators dispose of respiratory mask filters after 40 hours of use or 30 days, whichever comes first. Filters should also be disposed if they become damaged, soiled, or breathing becomes difficult.

52 Association for Organics Recycling, *Health and Safety at Composting Sites: A Guide for Site Managers* (2012). pg 17.

53 NYC Compost Project Hosted by LES Ecology Center, *Health and Safety Policies* (2019).

54 Personal communication, Caroline Bragdon, New York City Department of Health and Mental Hygiene, Bureau of Veterinary and Pest Control Services, March 19th, 2019.

55 Caroline Bragdon, "Keep Rats Out of Your Garden", Brooklyn Botanic Garden. [https://www.bbg.org/gardening/article/managing\\_rats\\_in\\_city\\_gardens](https://www.bbg.org/gardening/article/managing_rats_in_city_gardens) (accessed March 2019)

# Community Composting Best Management Practices

A review of best management practices (BMPs) for small-scale composting sites.

## BEFORE YOU BEGIN

- Do your homework
  - Get trained in the art and science of **composting**.
  - Map out a realistic plan: what will you **compost**, who's on your team, what's your end goal?
  - Be aware of existing composting rules and regulations.
- Choose your location and develop a site plan
  - Get to know your potential neighbors.
  - Observe the site. Avoid standing water on the site, even after a rain event.
  - Map out the entire composting process and where everything will be stored.
  - Secure a water source for adding to composting piles (as needed) and cleaning up.
- Choose an animal-resistant composting system:
  - Cover your active composting piles, particularly open windrows, with a **biocover** or other **semipermeable cover**.
  - Use concrete pads or fully enclosed systems for active composting piles.
- Identify site operators and managers that are trained in BMPs.
  - What will be your management plan and schedule?

## GETTING STARTED

- Create your recipe: two to three parts **browns** to one part **greens**.
- Avoid problem materials: dairy, meat, oils, fats, grease, diseased plants, aggressive grasses, and weeds.
- Secure **feedstocks**, tools, and composting process at all stages from weather, **pests**, and people.

- Secure a reliable source of browns, especially if processing food scraps, animal manures, and other highly putrescible materials.
- Focus on the flow of your site, avoid bottlenecks and clutter. People "smell with their eyes." Rats like places to hide.
- Proactively engage your neighbors! Put up informational signage.
- Start small and simple! Don't bite off more than you and your team can manage. Get a handle on your process, then slowly expand.



▲ Informational signage guides participants on washing buckets used to store food scraps at the NYC Compost Project hosted by Earth Matter NY. Source: Institute for Local Self-Reliance.

## AVOIDING RODENTS

- Place your composting system as far away from any dumpsters or trash cans as possible, or at least make sure that trash cans are well sealed.
- Maintain a buffer of at least 2 feet between your composting system and exterior walls, fences, shrubs, or any other potential hiding spaces for rodents and other animals. A minimum 3-foot buffer is needed around sidewalks, building foundations, concrete slabs, and footings to prevent burrowing. Keep this buffer area clear at all times.
- Set up your system, including the clutter-free buffer zone, on a paved pad. If using an enclosed system, a gravel pad can also be used. A gravel pad should be at least 6 inches deep and use 1-inch diameter or larger stones. If on a paved surface, add an additional strip of gravel 2 feet wide around its edge.

- Rats do not like to feel exposed, so don't give them places to hide! Avoid clutter, piles of materials, tall grasses, and low shrubs around your composting system. If piles of materials are unavoidable, make sure to move them around periodically to prevent housing any unwanted residents.

### CONSIDERATIONS FOR SITES COMPOSTING ANIMAL MANURES AND FOOD SCRAPS FROM MORE THAN ONE HOUSEHOLD

- For sites that are composting animal manures and food scraps from more than one household – particularly those creating compost for use in food production – active management, **thermophilic** “hot” conditions, and meeting **Process to Further Reduce Pathogens (PFRP)** guidelines are recommended.
- Achieve thermophilic conditions by:
  - using an appropriate recipe with sufficient porosity,
  - providing piles with sufficient moisture (but not too much),
  - mixing ingredients thoroughly,
  - building a pile of sufficient size,
  - monitoring temperatures,
  - turning compost piles as temperatures indicate.
- Meet PFRP guidelines:
  - For aerated open piles, bin and in-vessel systems with good insulation (in a vessel or covered with a finished or clean material): active piles should reach 55°C (131°F) or higher for 3 consecutive days.
  - For passively aerated or turned open piles: active piles should reach 55°C (131°F) or higher for at least 15 days (can be nonconsecutive), and receive a minimum of five turnings with at least 3 days between turnings.
- Do not store food scraps, which are highly **putrescible**, onsite unless they have been **bokashi**-fermented. The fresher the food scraps, the better. If food scraps cannot be processed into the compost pile immediately, at minimum, add brown material to soak up liquids and prevent **anaerobic** conditions.
- Always have enough browns on site.

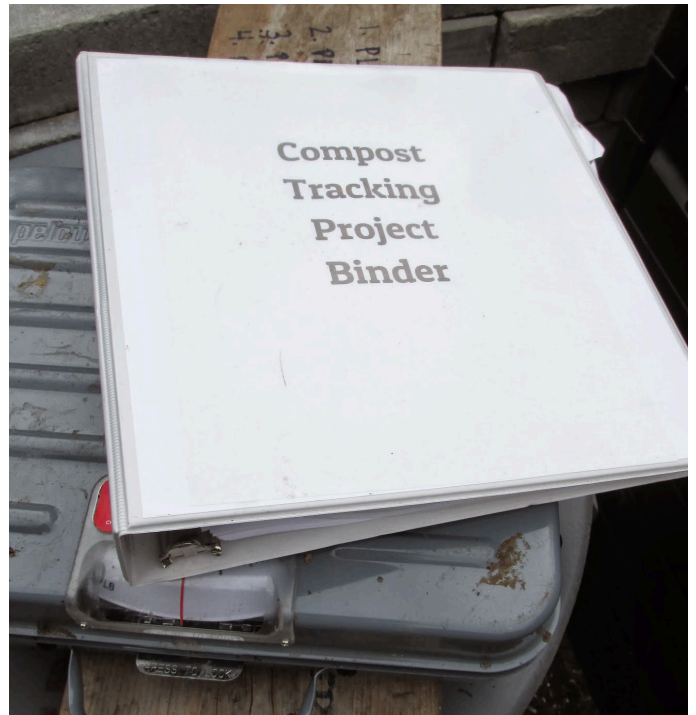

▲ The Prospect Heights Community Farm tracks management of the composting system and the pounds of food scraps being added. Source: Institute for Local Self-Reliance.

- Prevent water that comes in contact with animal manures, raw food scraps, or actively composting piles from entering streams or other bodies of water, or touching edible plants. Minimize **contact water** and filter through a meadow, berm, or filtration rain garden. Local rules may determine how this liquid needs to be managed.
- Use layers of material at the base of piles and to cap piles to maintain **aerobic** conditions, help manage odors, keep flies away, and contain fungal spores.
  - 6 inches of course browns, such as wood chips, make a good base.
  - Cap your pile with a semipermeable cover, or a biocover: at least 2 inches of finished (screened) compost, 6 inches of unscreened compost, or 12 inches of **overs** to prevent pest problems and avoid any nuisance smells.
- Be sure to build composting piles that are of sufficient size (at least 27 cubic feet) and stop adding material as you begin the PFRP process.
- If temperatures don't rise to a thermophilic range within a couple of days of building a pile of sufficient size, or if nuisance odors arise, troubleshoot immediately.



- During the active or thermophilic phase, observe your piles and turn regularly, driven by your observations. At a minimum, turn piles when the temperature peaks and starts to fall, or when temperatures surpass 160°F.
- If problems arise, be ready to cut off food scrap deliveries. These may include complaints from neighbors or regulators, rodent infestations, shortage of browns, or other unmanageable issues.

### MONITORING AND RECORDKEEPING

- Monitor for animal activity and take immediate action to make and keep your site inhospitable to pests.
- For sites composting animal manures and food scraps from more than one household – particularly those creating compost for use in food production – track temperatures, odors, and moisture levels.
- Use compost thermometers, the hand-squeeze test, and your nose to gauge and record temperatures, moisture content, and odor levels throughout the composting process. Allow these measurements to guide your management. This will help assure thermophilic composting conditions are achieved, and nuisance issues and unwanted attention are avoided.
- Record these measurements so you can re-create successful compost mixes, avoid problematic ones, and back up your project in case curious regulators or members of the public inquire.

TABLE 4. IDEAL INITIAL PARAMETERS FOR THERMOPHILIC COMPOSTING

Characteristic	Ideal Range
Moisture (%)	50 - 60
C:N	25:1 - 40:1
Oxygen (%)	> 10
Temperature (°F)	120 - 155
Particle Size (inches)	1/8 - 2
Bulk Density (pounds/cubic yard)	800 - 1000
Pile Size (cubic yard)	> 1

Source: Adapted from the USCC Compost Operations Training Program (2015).

### FINISHING AND TESTING

- **Cure** your compost, or allow the composting process to gradually come to a complete finish, in order

to produce a chemically stable finished product. Unfinished compost can damage plants.

- Allow a minimum of 4 weeks for curing; 2 to 4 months are preferable.
- Protect or monitor curing and finished compost piles from weather and pests. If employing an open pile system on a sloped site, make sure curing and finished compost piles are uphill of any active piles or raw feedstocks.
- Make sure there are no recognizable original feedstocks in the curing and finished compost. Overs such as tough woody materials and contaminants, like plastic and metal, can be screened out.
- Regularly test your compost quality, especially if you are producing compost for sale, creating compost for food production, or accepting materials that have the potential for pathogens (such as manures, meat, and large amounts of food scraps from off-site).

### MANAGING YOUR TEAM

- Avoid burnout! Make sure you have enough managers to allow people time off, particularly in volunteer-managed projects.
- Be realistic. Think about what your dependable labor force can handle. Your ability to enact BMPs should determine what and how much your site is composting.
- Set regular and consistent work days if engaging the community. Have someone responsible for this outreach.

### HEALTH AND SAFETY

- Identify all potential hazards present on your site and create basic operating procedures to manage them.
- Be prepared to act on participant safety concerns in a meaningful way as soon as possible.
- Inform participants about ***Aspergillus fumigatus***, a common fungal species found in soil, decomposing leaves, and compost that some people will be sensitive to.
- Wear gloves and wash your hands after removing gloves.
- Rinse composting tools after use and do not use for gardening.

- Protect those likely to be most sensitive. Involve participants and guardians where appropriate to discover anyone potentially susceptible: those with allergies, asthma, weakened immune systems, or who are infection prone.
- Have respirator masks (N95 mask recommended) available for use in dry, dusty conditions and to protect from bioaerosols, particularly for those who have asthma, other respiratory issues, or cystic fibrosis.
- Dispose of all exposed composting materials on site if active rodent burrowing or fresh urine or droppings are present as they may be infected with **Leptospirosis**, a bacterial disease. Take immediate action to make your site inhospitable to rodents. Contact pest management professionals if the problem cannot be remedied quickly.

# Appendix A: Glossary of Terms

**Aerobic:** relating to, involving, or requiring free oxygen.

**Ambient temperature:** the temperature of the surrounding environment.

**Anaerobic:** relating to, involving, or requiring an absence of free oxygen.

**Aspergillus fumigatus:** a common fungal species found in soil, decomposing leaves, and compost that can become airborne and to which susceptible individuals (such as those with suppressed immune systems, illnesses, or diseases affecting the lungs) may be sensitive.

**Bioaerosols:** microbes and other living biological particles suspended in air.

**Bioassay:** a method for testing for the presence of phytotoxic compounds in compost. Testing for seed germination and plant growth are common compost bioassays.

**Biocover:** a material such as compost or rich in carbon that is used to cap compost piles, such as a layer of at least 2 inches of finished compost, 6 inches of unscreened compost, or 12 inches of woody compost overs.

**Bokashi:** a method of preserving food scraps in an anaerobic, lactic acid fermented state. If done correctly, this process helps reduce odors and allows food scraps to be stored for some time before being composted.

**"Browns":** materials relatively high in carbon such as fall leaves, wood chips and shavings, straw, shredded newspaper, and woody yard and garden trimmings. Browns are key to the microbes' balanced diet as they provide the energy needed to metabolize proteins and other nitrogenous compounds.

**Bulk Density:** the weight of a certain volume of a material. In composting, bulk density is used to estimate porosity in a mix of materials. For example, the average bulk density of wet food scraps is 1,000 pounds per cubic yard. The ideal bulk density of an initial material mix for composting is lighter, around 800 pounds per cubic yard.

**Bulking agent:** a material that increases porosity and improves the structure of a compost pile, such as wood chips.

**Cation Exchange Capacity (CEC):** the capacity of the soil to attract and hold on to positively charged mineral ions, or cations. A soil's CEC is increased by the presence of clay and organic matter.

**Cellulose:** the primary substance that makes up plant cell walls.

**"Chimney Effect":** describes how air circulates in a compost pile. In a properly built aerobic compost pile, air circulates much like in a house with a hot fireplace and a chimney. As the center of the pile heats up, hot air rises from the middle which pulls cool air into the pile.

**Compost:** a dark, crumbly, earthy-smelling and humus-rich material produced by the natural aerobic decomposition of organic materials such as garden residuals and food scraps. When added to soil, compost improves its biological, chemical, and physical characteristics, making the soil a better home for plants and beneficial soil organisms.

**Composting:** the transformation of raw organic materials into compost via the process of aerobic decomposition. It is a natural process that is driven by microorganisms, like bacteria and fungi, which break down organic materials for energy. Composting is the way that nature recycles! We can speed the process by creating the ideal conditions for the microbes to thrive: adequate airflow, sufficient moisture, and the right recipe or food.

**Contact water:** any water that has come into contact with raw feedstocks or actively composting material. It is not compost tea and needs to be kept from running off-site into waterways and food growing areas. This liquid may contain pathogens and a high-nutrient load. (Note: often referred to as leachate, a term we reserve for the toxic liquid leaking from landfills.)

**Curing:** marked by a sustained drop in temperature back into the mesophilic range. As the pile cools down, fungi and actinobacteria become more active, metabolizing the more complex cellulose and lignin rich materials. While composting has slowed down during this stage, it is still occurring, and the humus content of the pile is increasing. After being given some time to cure and mature (at least

4 weeks, but sometimes multiple months), the compost has reduced plant toxins and will have a lower amount of oxygen and nitrogen.

**Electrical Conductivity (EC):** the ability of soluble salts in compost to carry an electric current.

**Homogenous:** having uniform or similar characteristics. The final product of the composting process should be homogenous, meaning everything is a similar color and texture and none of the original raw feedstocks should be identifiable.

**Humus:** the dark, complex, stable, carbon-rich organic matter that results from the natural decomposition of organic materials. It increases the capacity of soil to store water and sequester, or store, carbon from the atmosphere.

**Feedstocks:** raw material inputs for the composting process; these organic material substrates are food for the microorganisms that power the composting process.

**Fitness for use:** testing that gauges a compost sample's fitness for use measures the level of free ammonia and volatile organic acids present in compost. Compost is considered fit for use when these compounds are no longer present as they are toxic to plants.

**"Greens":** materials relatively high in nitrogen such as raw vegetable and fruit scraps, coffee grounds, fresh grass clippings, and garden scraps. High-nitrogen materials help the microbes produce proteins. Greens often can also provide needed moisture in the pile.

**Leptospirosis:** a bacterial disease that affects humans and animals. In urban areas, rodents can be vectors for this disease.

**Lignin:** a complex and slow-to-decompose organic substance that makes woody materials rigid.

**Macroorganisms:** larger organisms that mostly act as "shredders," chewing materials into smaller pieces that are more accessible to microbes. Animals and insects such as snails, earthworms, nematodes, millipedes, flies, and beetles are "shredders" that thrive in mesophilic conditions (temperatures less than 105°F).

**Mesophilic:** the phases of the composting process that occur between 50 - 104°F. During the first mesophilic

phase, mesophilic bacteria will begin to eat substrates with high-energy yield like sugars, starches, and fats. A compost pile will return to a mesophilic range during the curing process.

**Microorganisms (or microbes):** the powerhouses of the compost pile, chemically transforming raw materials into stabilized humus. They are too small to see with the naked eye. In a pile, bacteria rush to eat up the fruit and vegetable scraps, which are full of simple and energy-rich components such as sugars and starches. As they work, they generate heat in the pile and allow other microorganisms to begin their work.

**Organic materials:** anything that was once alive and can be decomposed by composting organisms. Organic materials in feedstocks are what feed the composting organisms.

**Organic matter:** organic material that has been stabilized by the decomposition process. It is an output of the composting process. Compost is a source of organic matter for the soil.

**Overs:** Big pieces or "leftovers" from the compost screening process, often lignin-rich materials, such as wood chips and branches, that do not fully break down in one pass through a compost system. Overs can also include contaminants such as plastics that are screened out.

**Passive or cold composting:** a low-effort method of composting that involves little attention to turning and watering or otherwise optimizing composting conditions. Because the composting process is not optimized, materials won't break down quickly and producing finished compost may take more than a year. Weed seeds and pathogens may persist, as temperatures above 130°F are needed to kill them. This method is not appropriate for community sites composting food scraps.

**Pests:** include rodents, flies, cockroaches, and other unwanted animals and insects that can act as vectors of pathogens and disease.

**pH:** a scale that represents the relative acidity or alkalinity of a substance.

**Phytotoxic:** a compound that is toxic to plant growth.

**Process to Further Reduce Pathogens (PFRP):** compost processing time and temperatures should be sufficient to

kill most weed seeds, and reduce pathogens such as E. coli or salmonella, and vector attraction (unwanted critters).

**Putrescible:** a material that decays and putrefies easily.

**Runoff:** refers to water that drains off a compost site.

**Selectively permeable covers:** fabric covers used to protect actively composting piles, curing piles and finished compost piles by shedding rainfall, blocking UV rays, while still allowing piles to breath.

**Solarization:** involves using radiant heat from the sun to kill pests, pathogens, and unwanted seeds. Most simply, this can be achieved by placing the material to be treated in a black plastic trash bag and leaving it in a sunny spot for four to six weeks.

**Stability:** can be gauged by the amount of energy-rich feedstocks remaining for composting microbes to consume and whether or not decomposition is still occurring. Stable compost will have no remaining feedstocks for microbes to consume.

**Thermophilic:** the phase of the composting process where temperatures reach above 104°F. During this stage, heat-tolerant bacteria continue to eat simple compounds with high-energy yield. With sufficient food, water, and air, these microbes can bring the temperature up to 150°F or higher. Most weed seeds are killed at 145°F, but tomato seeds may persist until around 153°F. Much above 155°F, composting microbes begin to die off and decomposition slows.

**Thermophilic composting:** a method of composting that involves more attention to piles so that they achieve temperatures higher than 104°F. This approach produces a finished product more quickly than passive composting does. In order to reach optimal temperatures to kill weed seeds and pathogens and speed the process, you will need to regularly turn the pile and maintain adequate moisture.

# Appendix B: Troubleshooting FAQ

While problems can arise, the beauty of composting (particularly small-scale community composting) is that issues can generally be effectively remedied with a bit of effort and “elbow grease.” The Troubleshooting Table in *Appendix C* provides additional solutions to common problems.

## **Question: What do I do if my pile is not heating up or “cooking”?**

If the pile is not heating up, make changes to create hospitable conditions for microorganisms to thrive. This includes initially using or remixing in a proper ratio of two to three parts by volume browns to one part by volume greens, adding water to maintain an adequately moist system (ideal moisture content is 50 to 60 percent), and turning to fluff materials to create airflow within the pile.

## **Question: My pile stinks. What do I do?**

Maintaining an aerobic (i.e. oxygen-rich) environment helps to avoid unpleasant odors that often arise due to anaerobic (i.e. without oxygen) composting conditions. Composting systems that have too much nitrogen (i.e. C:N ratio is too low), are too wet, have a poor or compacted structure, or are turned too infrequently can have nuisance odors. Rebuild the pile adding more browns, especially bulky materials such as wood chips, and increase turning frequency to get rid of anaerobic pockets. While it is normal for composting to have some odors, proper maintenance prevents the odor from becoming a nuisance.

## **Question: How do I deter rats and other rodents?**

Like most issues, the best way to minimize rat and pest issues is with preventative maintenance. This is achieved through proper management. Promptly handle and process putrescible high-nitrogen materials. They should be mixed with browns immediately and not left to attract pests or go anaerobic. Utilize composting systems that make it extremely difficult for rodents to enter the system, such as a wooden bin system with spaces smaller than the size of a rat’s snout or head (e.g. using 1/4-inch hardware cloth). Systems should be consistently secured (e.g. by

locking lids and sealing any storage containers) and sites kept free of stray food scraps and trash that might attract rodents. Scrupulously incorporate all bits of food that may be around the pile. Control odors to avoid attracting pests. Properly maintain your system and always cover any exposed food scraps with a carbon source (such as wood chips) or finished compost. Piles “sealed” with a uniform depth of at least 6 inches will be of less interest to rodents. Selecting fruit, vegetable, and acceptable food scraps can also minimize rat problems. Rats seek out protein and fats found in unacceptable feedstocks like meats, fish, and oils.

Rodents do not like open spaces as open spaces make them nervous about predators. Consider where the system, storage containers, and curing piles are located. Place these with open space all around. To prevent habitat formation at the base of the composting system, where it’s nice and warm for rodents through the winter, bins ideally should have a barrier (like cement, a dug-out pit with sand, or something else inhospitable).

If your site has pressure from urban rodents, consider keeping browns, curing compost, and finished compost in above-ground tumblers (such as those sold as backyard composting systems).

## **Question: What materials do I need to be careful of composting?**

Err on the side of caution and avoid any questionable material. Meat, cooked food, cheese, and oils can lead to odors that attract rodents. Minimize woods with natural herbicides such as walnut, cypress, cedar, and white oak. Be careful of wood shavings from pressure-treated woods or that might have toxic glues. Avoid grass clippings from lawns treated with herbicides or pesticides.

## **Question: Can I add pet or other animal poop to my pile?**

No. Dog and cat feces can contain parasites and harmful disease organisms. While manures, such as from cows, horses and chickens, are generally acceptable materials to compost, they require extra attention due to the potential for pathogens or negative impact from owners’ use of medications. Manure should only be added to systems with active management and monitoring of temperatures to assure the requirements of the Process for Further Reducing Pathogens have been met. Make

sure to check local regulations about animal manures before including them. Horse manure in particular can be a source of persistent herbicides, which in extremely minute concentrations can contaminate compost.<sup>56</sup>

### **Question: Will composting kill weed seeds?**

Most weed seeds will be killed if pile temperatures reach 140°F for at least three continuous days. Some seeds, like tomato seeds, need temperatures of 153°F. However, to be safe, one can use a solarization process before composting or refrain entirely from including weeds that are in flower or have seed heads. Solarization involves using radiant heat from the sun to kill pests, pathogens, and unwanted seeds. Most simply, this can be achieved by placing the material to be treated in a black plastic trash bag and leaving it in a sunny spot for four to six weeks.

### **Question: How long does it take to produce finished compost?**

While this can vary significantly, composters that maintain optimum conditions in small-scale, community-based composting operations can produce finished compost in approximately 3 to 5 months. Always allocate adequate time for the curing phase in which the compost becomes stable and mature.

### **Question: What do I do about standing water near my pile?**

You don't want standing water on your site. Bins or containers need to sit on a foundation that addresses any "contact water" (water that has come in contact with the active composting process). On cement, for instance, contact water can be spotted and soaked up quickly with wood shavings that are incorporated back into the bin. If a foundation, like bare earth, soaks up contact water, over time it can smell. Do not let "contact" water run off or drain into streams or other surface water.

---

<sup>56</sup> For more information on potential problems with persistent herbicides, visit the U.S. Composting Council website at <https://compostingcouncil.org/persistent-herbicides/>

# Appendix C: Troubleshooting Table

Adapted with permission from the NRAES *On-Farm Composting Handbook*.

Composting System Condition	Possible Source or Reason	Other Clues	Recommended Remedy
Composting system fails to heat	Materials too dry	Cannot squeeze water from material	Add water or wet ingredients
	Materials too wet	Materials look or feel soggy; compost pile slumps; moisture content >60%	Add dry ingredients (leaves, straw, wood chips) and remix
	Not enough nitrogen, materials are slowly decomposing	Large amount of woody materials	Add high nitrogen ingredients; alter composting recipe
	Poor structure	Composting system pile settles quickly; few large particles; not excessively wet	Add wood chips, straw, build in dome shape
	Cold weather and small composting system pile size	Composting system pile size is less than 3.5 to 4 ft.	Enlarge or combine composting system piles; add highly degradable ingredients (fruit and veggie)
Temperature falls consistently over several days	Low oxygen; need for aeration	Temperature declines gradually rather than sharply	Turn or aerate composting system pile
	Low moisture	Cannot squeeze water from material	Add water
Uneven temperatures or varying odors in composting system pile	Poorly mixed materials	Visible differences in the composting system pile moisture and materials	Turn/remix composting system pile
	Uneven airflow	Poorly mixed materials	Remix composting system pile and build in dome shape
	Materials at different stages of maturity	Poorly mixed materials	None required
Gradually falling temperatures; composting system pile does not reheat after turning or aeration	Composting nearing completion	Approaching expected composting time period; adequate moisture available	None required
	Low moisture	Cannot squeeze water from materials	Add water and remix
Composting system pile overheating (temperature >150°F)	Insufficient aeration for heat removal	Composting system pile is moist	Turn composting system pile
	Moderate to low moisture; limited evaporative cooling	Composting pile feels damp but not excessively wet or dry	Add water; continue turning and aeration to control temperature



Extremely high temperatures (>170°F) in composting system pile, curing pile, or storage materials	Pyrolysis or spontaneous combustion	Low moisture content; composting system pile interior looks or smells charred	Maintain proper moisture content; add water to charred or smoldering sections; breakdown pile and properly rebuild
High temperatures or odors in curing or finished compost storage pile	Compost is not stable	Short active composting period	Compost is not in curing stage, keep turning compost and tracking temperature and moisture
Ammonia odor coming from composting system pile	High nitrogen level	C:N ratio < 20:1	Add high-carbon materials
	Slowly available carbon source	Large woody particles; C:N ratio <30:1	Use another carbon material such as leaves or increase the carbon proportion
Rotten-egg or putrid odors coming from composting system pile	Anaerobic conditions	Low temperatures	Turn composting system pile
	Anaerobic conditions - materials too wet	Low temperatures	Add dry materials
	Anaerobic conditions - poor structure	Low temperatures	Add wood chips, straw, and rebuild in dome shape
	Anaerobic conditions - composting system pile is compacted	Low temperatures	Remix and rebuild in dome shape
	Anaerobic conditions - insufficient aeration	Low temperatures	Turn composting system pile to increase airflow rate
	Anaerobic conditions - pile too large	High temperatures	Break down composting system pile, remix with accurate recipe, and rebuild smaller pile
	Anaerobic conditions - airflow uneven	High temperatures	Break down composting system pile, remix with accurate recipe, and rebuild proper structure and size
Odors generated only after turning	Odorous raw materials	High temperatures	Frequent turnings; add carbon to absorb and mitigate odors
	Insufficient aeration; anaerobic interior	Falling temperatures	Shorten time interval between turnings; add high-carbon materials, especially wood chips
Site-related odors (composting system pile not odorous)	Raw materials	Odor is characteristic of the raw material	Handle raw materials promptly with minimal storage
	Nutrient-rich puddles because of poor drainage	Standing puddles of water; ruts in ground surface or hardscape pad	Divert runoff properly; maintain pad surface

Fly or mosquito problems <i>(Note: black soldier flies are usually not a problem)</i>	Flies breeding in compost system pile	Fresh nitrogen materials exposed; flies hovering around composting system pile	Turn composting system pile every 2 to 3 days; cover with 6- to 12-inch layer of compost or carbon source
	Flies breeding in raw materials	Wet raw materials stored onsite longer than several days	Handle raw materials promptly; properly mix into composting system pile
	Mosquitoes breeding in stagnant water	Standing puddles of water; nutrient-rich receiving waters	Water effectively by showering compost pile while mixing; keep standing pools of water away from composting system pile
Finished compost contains clumps of materials and large particles; texture is not uniform	Poor mixing of materials or insufficient turning	Original raw materials discernable in compost	Screen/sift compost; improve initial mixing
	Airflow uneven	Wet clumps of compost	Screen/sift or shred/break compost into smaller bits; improve air distribution
	Raw materials contain large particles and non-degradable or slowly degradable materials	Large, often woody, particles in compost	Screen/sift compost; shred/break compost into smaller bits
	Active composting not complete	Curing pile heats or develops odors	Lengthen composting time or improve composting conditions

## Appendix D: Sample Composting Pile Monitoring Log

The next page provides a sample compost monitoring log for tracking compost pile observations. Use the hand-squeeze moisture test on page 37 to estimate the moisture content. Observing the temperature in at least two spots in your pile (for example, one towards the middle, the other towards the outside) will help give you a more complete picture of what's going on.



COMPOSTER TRAINING PROGRAM

Composting Pile Monitoring Log								
Date/Time	Composter Name(s)	Estimated Moisture Content (%)	Odor Rating (Poor, Fair, Good)	Temp 1	Temp 2	Pile Turned (Y/N)	Notes/Observations/Actions	

# Appendix E: Community Composting in Georgia

This Guide was funded in part by a grant from the U.S. Environmental Protection Agency's Region 4 office to create a resource for community composters in the state of Georgia. While the preceding sections and appendices of the Guide will be applicable to community composters anywhere in the country, this appendix summarizes specific regulations relevant to community-scale composters in Georgia. For those outside Georgia, Georgia's rules provide a useful example of how composting at a small scale is regulated.

In Georgia, composting, mulching, and anaerobic digestion facilities are regulated under Rule 391-3-4-.16 of the Georgia Rules for Solid Waste Management, which is enforced by the Georgia Environmental Protection Division (EPD). All composting facilities not explicitly exempted from these regulations either fall under the permit-by-rule category or are required to obtain a solid waste handling permit. Permit-by-rule operations only need to meet some of the requirements that those seeking a solid waste handling permit do, making it significantly less expensive and more straightforward to get operational approval from EPD.

Most community composters in Georgia will either be exempt from the requirement for a solid waste handling permit or will fall under the permit-by-rule category. Whether a specific compost operation qualifies for an exemption or a permit-by-rule will depend on factors such as where the composting site is located, the type of feedstocks accepted, and the volume of food residuals, or food scraps, being received. The remainder of this document covers information from Rule 391-3-4-.16 that is most relevant to community composters. It provides an overview of relevant definitions and the requirements for exemption from a solid waste handling permit and for qualifying under the permit-by-rule category.

Compost operations requiring solid waste handling permits will need to secure a permit for the specific technology used and feedstocks processed. Information about solid waste handling permits is not included in this overview. Likewise, regulations pertaining to anaerobic digestion and composting animal mortalities and biosolids are also not covered, as they fall outside of the scope

of this **Guide to Best Management for Community Composting**. Please review Rule 391-3-4-.16 for more information on these topics.

## Definitions

"Source-separated Organics" are defined as organic material including, but not limited to, food residuals, food processing residuals, and compostable paper that has been separated from non-compostable material.

"Food Processing Residuals" are defined as organic material generated as a by-product of the food-processing sector that is non-hazardous and contains no domestic wastewater; it does not include dissolved air flotation skimmings or fats, oil, and greases.

"Food Residuals" are defined as pre- and post-consumer food used as a feedstock in a composting or anaerobic digestion facility.

## Feedstock Categories

The feedstocks a compost site accepts will help to determine whether the site is exempt from permit requirements altogether, or whether it is considered a permit-by-rule site. The feedstock categories that will most likely apply to community-scale composters are as follows:

**Feedstock Category A:** Yard trimmings, land-clearing debris, agricultural residuals generated and processed on site, untreated and unpainted wood, or any combination thereof.

**Feedstock Category B:** Agricultural residuals generated off site, herbivorous animal manure generated at a zoo,\* and/or source-separated organics.

\*herbivorous animal manure generated at a zoo is not allowed for permit-by-rule category facilities.

Approval from EPD may be necessary to determine the appropriate category for a particular feedstock if it's not explicitly listed above. If the latter, EPD may require further information from the site owner or operator to assist in making such determinations. At a minimum, EPD will require operations to have potential feedstocks analyzed for metals, C:N ratio, and soluble salts.

## Exemptions

The following mulching and composting operations are exempt from the requirement for a solid waste handling permit:

1. Backyard composting
2. A facility composting or mulching only Category A feedstock
3. A facility processing less than 40 tons per year of food residuals generated on site and composted in leak-proof containers that prohibit vector attraction and prevent nuisance odor generation
4. Composting of food residuals and yard trimmings generated on site at a K-12 institution for educational purposes
5. Manures managed in accordance with the Georgia Rules for Water Quality Control

Certain exemptions also exist for biosolids and animal mortality composting, and anaerobic digestion. As mentioned in the introduction of this appendix, these topics fall outside of the scope of this guide.

### Permit-by-Rule

Compost operations not included in the above list of exemptions may fall under the permit-by-rule category. Sites composting Category A and B feedstocks that meet both of the following criteria may operate under a permit-by-rule:

- Facilities receiving less than 500 tons of Category B feedstock per calendar month
- For Class 2 facilities, Category B feedstocks shall be restricted to exclude the receipt of non-vegetative food processing residuals and manures

Non-vegetative food processing residuals are defined as “organic material generated as a by-product of the food-processing sector that is non-hazardous and contains no domestic wastewater.” Sites qualifying for the permit-by-rule category are considered Class 2 composting facilities under the Rule.

### Design and Operating Standards

New composting operations qualifying under the permit-by-rule category are required to comply with the design, operating, and siting standards for Class 2 composting facilities.

The design standards for permit-by-rule operations include:

- The composting area shall be constructed to maintain its structural integrity under operating conditions and be capable of supporting vehicular traffic.
- The composting facility shall be adequate in size and capacity to manage the projected volume of compost and residue generated. The areas for storing feedstocks prior to processing shall be clearly defined and the maximum capacity specified.
- For windrow operations, the maximum composting process windrow size and minimum composting process windrow spacing shall match the capability and requirements of the equipment used at the facility.

The operating standards for Class 2 facilities include:

- The composting facility shall have a sign at its entrance that lists the name of the facility, hours of operation, feedstocks accepted, and emergency contact information.
- The composting facility shall have stormwater control measures.
- The composting facility shall prevent flow of contact water from the active composting area into surface water and curing or finished compost areas.
- Suitable measures to control vectors shall be applied.
- Suitable measures to control odors shall be applied.
- Suitable measures to prevent, control, and extinguish fires shall be applied.
- By the end of each operating day, all incoming Category B feedstock must be processed into the active composting area, transferred to leak-proof containment, or mixed with bulking material and covered in a manner that minimizes nuisance odors and scavenging by vectors.
- No material shall be stored in excess of the designated capacity.
- Storage of finished compost on site is limited to 12 months, unless approved by the Division on a case-by-case basis.

- Non-compostable material and solid waste generated on site shall be stored in a waste container and then either recycled or disposed of at a permitted solid waste facility.
  - Facilities accepting Category B feedstocks from off site shall track incoming feedstocks and finished compost. Records documenting compliance of the composting facility with these Rules shall be kept for a minimum of three years in a form suitable for submission to or inspection by the Division. Records shall include the weight or volume (in tons or cubic yards) of the feedstocks accepted, total compost produced, and any amount sold or used. Records shall be retained at the composting facility unless an off-site storage location is approved by the Division.
  - Operation and management shall be under the supervision and control of an individual properly trained in the operation of such facilities at all times. Facility operations managers must be able to document training in the basics of composting facility operations.
  - Notice of final closure shall be provided to the Director within 60 days from final receipt of feedstock. Any site not receiving feedstock in excess of 180 days, unless properly closed or otherwise approved by the Division, shall be deemed closed and in violation of these Rules. Notice of closure shall include documentation that all feedstocks and active, curing, and final compost materials have been removed from the facility and that the site has been stabilized in accordance with the Manual for Erosion and Sediment Control in Georgia.
3. A 200-foot buffer shall be maintained between the composting operation and any adjacent residences and/or drinking water supply wells.
  4. A 50-foot buffer shall be maintained between the composting operation and all streams.
  5. A description of surrounding land uses up to a half-mile radius shall be provided.
  6. Airport safety restrictions, as required by Rule 391-3-4-.05(1)(c) for MSWLF units, shall be met.

## Siting Criteria

Class 2 composting facilities shall comply with the following criteria:

1. The facility shall not be located in the 100-year floodplain.
2. A 50-foot undisturbed buffer shall be maintained between the composting operation and the property line.